

# COLLECTIONS 2023

SINTEROVANI KAMEN







CHINA



ITALY



ITALY



USA





USA



MALTA



CROATIA



UAE





SAN MARINO



KOREA



ISRAEL



ITALY





GERMANY



TAIWAN



USA



UKRAINE





BELGIUM



ITALY



USA

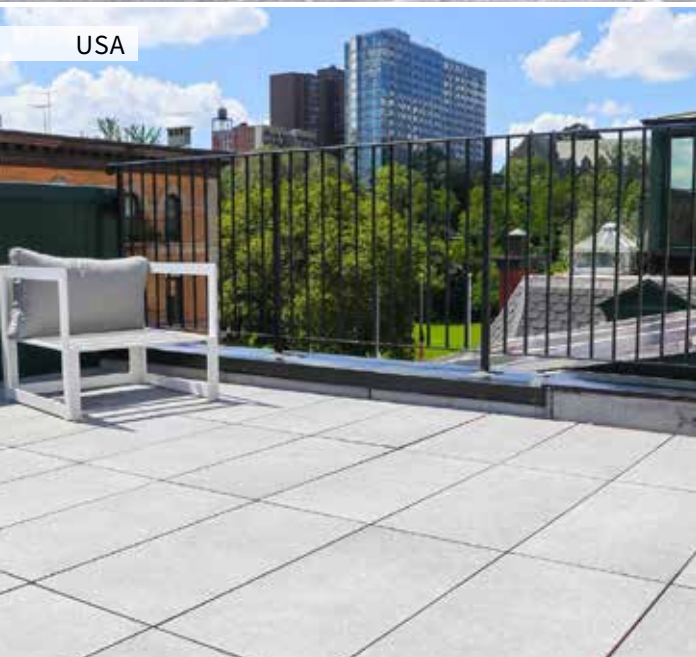

TAIWAN



NETHERLANDS





FRANCE



ITALY



SWITZERLAND



GERMANY





ITALY



UNITED KINGDOM



SWITZERLAND



ITALY





NETHERLANDS



GERMANY



UNITED KINGDOM



GREECE





# GRANULATI ZANDOBBIO

NAJBOLJI IZBOR



CERTIFIED COMPANY  
ISO 14001:2015 AND ISO 9001:2015



24 SIZES AND 200+ COLORS

**Granulati Zandobbio** su lideri u proizvodnji i distribuciji širokog asortimana proizvoda za pejzažnu arhitekturu: sinterovanog kamena i prirodnog kamena za popločavanje. U ponudu možete pronaći najveći izbor nijansi i formata za spoljne prostore.

BRENOVI

L'ALTRA  
**PIETRA**  
THE HIGH QUALITY  
OUTDOOR PAVING

HARDSCAPE®  
**PORCELAIN**

OUTDOOR  
WOOD 2CM

STONEGRES

SUPER HARD  
**KERAMIK 3**

CERA  
-PANEL



## SINTEROVANIKAMEN

Sinterovani kamen, vrhunski porcelanski kamen je materijal sa brojnim područjima primene u projektima spoljnog i unutrašnjeg uređenja.

Može se koristiti za popločavanje i oblaganje, za ventilisane fasade i bazene. Napravljen je od jedinstvanog spoja prirodnih minerala najvišeg kvaliteta, koji su sjedinjeni u kompaktnom obliku kroz proces koji ne zahteva upotrebu smole i hemijskih veziva - proces sinterizacije.

Dobijena površina ima ekstremnu otpornost na ogrebotine, visoke temperature, hemijske agense i UV zrake, uz visok nivo otpornosti na mrlje, gotovo nulti faktor apsorpcije i visoku mehaničku izdržljivost.

 DRIVE-OVER

 RESISTANT TO HEAVY LOADS

 RECTIFIED WITH BEVEL

 ANTISLIP

 LOW WATER ABSORPTION

 FIREPROOF

 NO TREATMENTS REQUIRED

 EASY TO CLEAN

 RESISTANT TO MILDEW AND MOSS

 THERMAL SHOCK RESISTANT

 RESISTANT TO CHEMICALS

 STAIN RESISTANT

 ABRASION RESISTANT

 FROST RESISTANT

 COLOR RESISTANCE TO LIGHT

## TEHNIČKI PODACI



# FORMATI

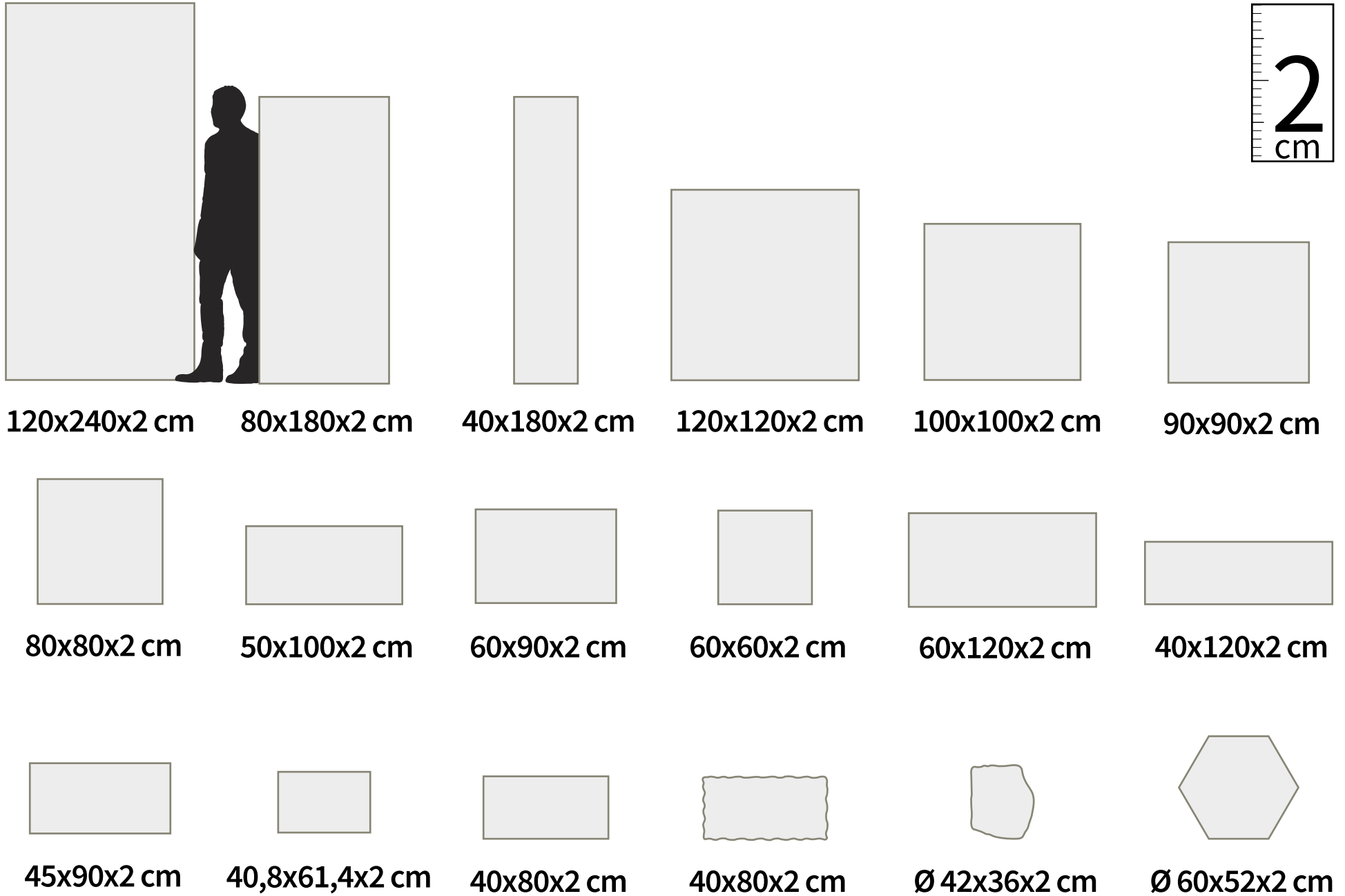



2  
cm

# L'ALTRA<sup>®</sup> PIETRA

THE HIGH QUALITY  
**OUTDOOR PAVING**

45x90x2 cm

60x60x2 cm

90x90x2 cm

40x120x2 cm

60x90x2 cm

100x100x2 cm

40x80x2 cm

60x120x2 cm

120x120x2 cm

50x100x2 cm

80x80x2 cm

120x240x2 cm



L'ALTRA PIETRA<sup>®</sup> je najkompletniji ekskluzivni brend sinterovanog kamena, odnosno visoko kvalitetni porcelanski kamen, pogodan za sva spoljna rešenja, zahvaljujući "full body" strukturi i brojnim nijansama. Kombinuje boje i formate sa estetikom koja je verna prirodnom kamenu: teksture, nesavršenosti, nijanse i sve ostalo što doprinosi stvaranju lepote i elegancije najcenjenijih materijala od kamena.





COLOSSEO GRIGIONI, 60x120x2 cm (24"x48"x0.8")  
HONG KONG, CHINA



L'ALTRA<sup>®</sup>  
**PIETRA**  
THE HIGH QUALITY  
**OUTDOOR PAVING**

KOREA



USA



PAVING FOR HIGH END PROJECTS

ITALY



TAIWAN





ITALY



USA



MALTA







COLOSSEO GRIGIONI, 60x60x2 cm (24"x24"x0.8")  
BRUSSELS, BELGIUM



# 2 COLOSSEO GRIGIONI



000291



010804



012103



010801

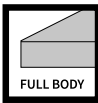

120x120x2 cm

60x120x2 cm

45x90x2 cm

60x60x2 cm



1 cm (0.4") R10 & R11 sizes in the section: - Formati da 1 cm R10 & R11 nella sezione: - Verfügbare Größen von 1 cm R10 & R11 im Bereich: - Tailles de 1 cm R10 & R11 dans la section: COMBINE Indoor & Outdoor  
120x240x2cm (48"x96"x0.8") in the XXL section - 120x240x2cm nella sezione XXL - 120x240x2cm im Bereich XXL - 120x240x2cm dans la section XXL



2  
cm

# COLOSSEO QUARZITE GIALLA

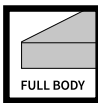

010701

60x60x2 cm







COLOSSEO QUARZITE GIALLA, 60x60x2 cm (24"x24"x0.8")  
BRESCIA, ITALY





COLOSSEO FIORA, 30x60x2 cm (12"x24"x0.8")  
SAN MARINO



# 2 COLOSSEO FIORA

L'ALTRA<sup>®</sup>  
**PIETRA**  
THE HIGH QUALITY  
OUTDOOR PAVING

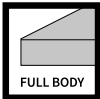

000266

60x60x2 cm





2  
cm

# COLOSSEO BASALT GRAU

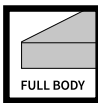

010601



60x60x2 cm

010104



60x120x2 cm







COLOSSEO BASALT GRAU, 60x60x2 cm (24"x24"x0.8")  
BERGAMO, ITALY





COLOSSEO PIETRA DI GERUSALEMME, 60x60x2 cm (24"x24"x0.8") - 45x90x2 cm (12"x36"x0.8")  
VERONA, ITALY



2  
cm

# COLOSSEO PIETRA DI GERUSALEMME

L'ALTRA<sup>®</sup>  
**PIETRA**  
THE HIGH QUALITY  
OUTDOOR PAVING



000295

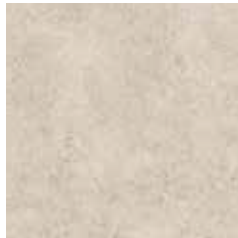

120x120x2 cm

012001



60x60x2 cm

011403

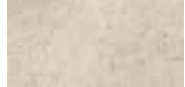

45x90x2 cm

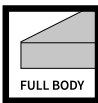

1 cm (0.4") R10 sizes in the section: - Formati da 1 cm R10 nella sezione: - Verfügbare Größen von 1 cm R10 im Bereich: - Tailles de 1 cm R10 dans la section: COMBINE Indoor & Outdoor  
120x240x2cm (48"x96"x0.8") in the XXL section - 120x240x2cm nella sezione XXL - 120x240x2cm im Bereich XXL - 120x240x2cm dans la section XXL

L'ALTRA PIETRA



2  
cm

# COLOSSEO BRESSA

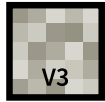

000293



120x120x2 cm

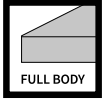

011001



60x60x2 cm

000221



60x120x2 cm



120x240x2cm (48"x96"x0.8") in the XXL section - 120x240x2cm nella sezione XXL - 120x240x2cm im Bereich XXL - 120x240x2cm dans la section XXL





COLOSSEO BRESSA, 60x120x2 cm (24"x48"x0.8")  
BERGAMO, ITALY





COLOSSEO PORPHYRBRAUN, 60x60x2 cm (24"x24"x0.8")  
TAIPEI, TAIWAN





# 2 COLOSSEO PORPHYRBRAUN

L'ALTRA  
**PIETRA**  
THE HIGH QUALITY  
OUTDOOR PAVING

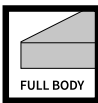

011901

60x60x2 cm

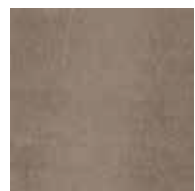



2  
cm

# COLOSSEO BARGE

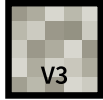

011704



60x120x2 cm

011301



60x60x2 cm

011703



45x90x2 cm

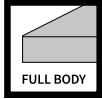



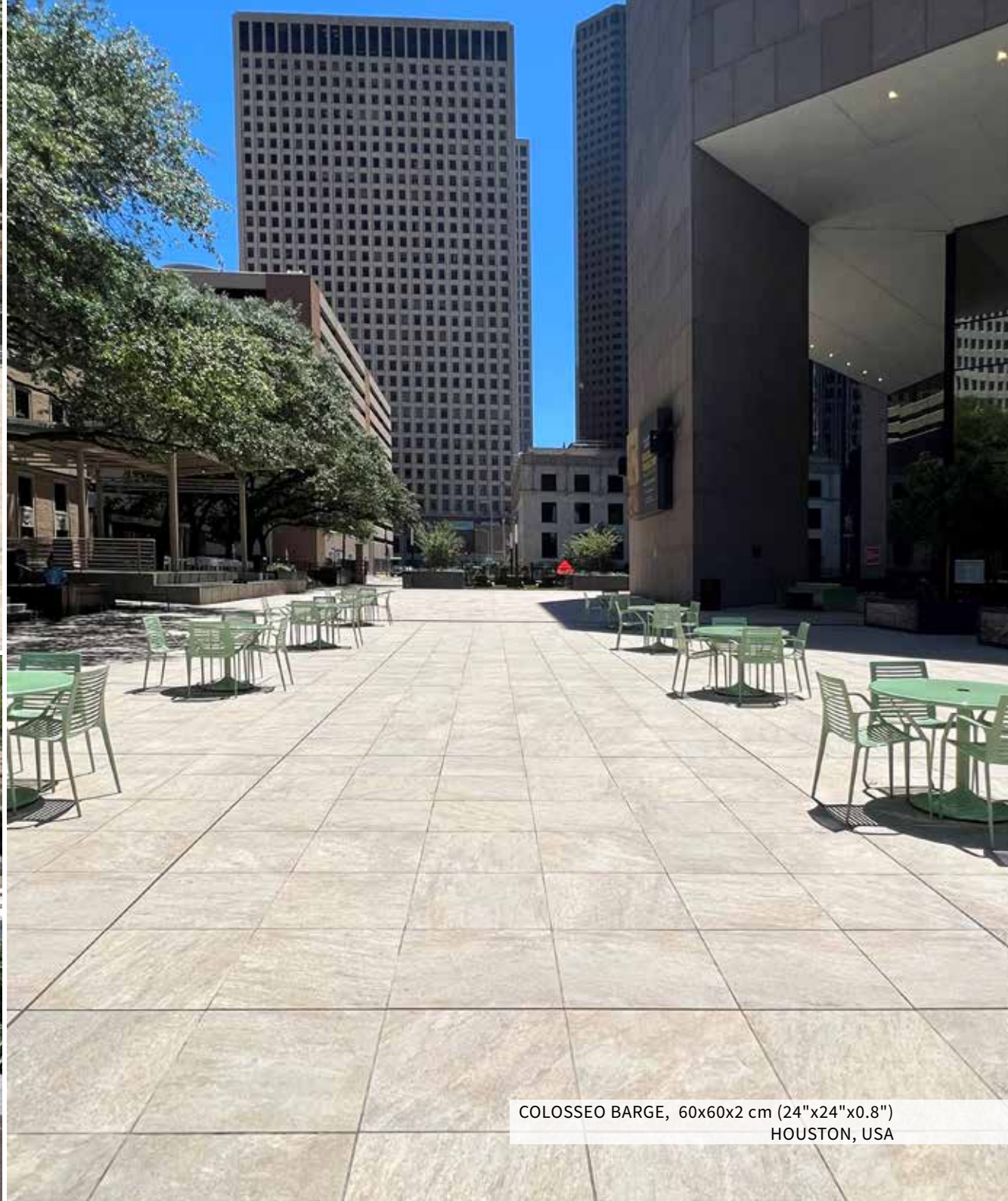

COLOSSEO BARGE, 60x60x2 cm (24"x24"x0.8")  
HOUSTON, USA





COLOSSEO SILVERGRAU, 30x60x2 cm (12"x24"x0.8")  
HONG KONG, CHINA



# 2 COLOSSEO SILVERGRAU

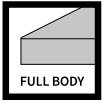

010304

60x120x2 cm



011801

60x60x2 cm





2  
cm

# COLOSSEO GLETCHER GRAU



010204



012101



000381

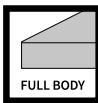

60x120x2 cm

60x60x2 cm

40x120x2 cm





# 2 COLOSSEO QUARZITE SVEDESE

L'ALTRA<sup>®</sup>  
PIETRA  
THE HIGH QUALITY  
OUTDOOR PAVING

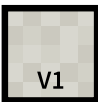

010501

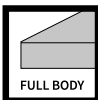

60x60x2 cm



1 cm (0.4") R10 sizes in the section: - Formati da 1 cm R10 nella sezione: - Verfügbare Größen von 1 cm R10 im Bereich: - Tailles de 1 cm R10 dans la section: COMBINE Indoor & Outdoor



2  
cm

# COLOSSEO TOSCANO

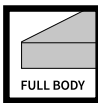

010901

60x60x2 cm







COLOSSEO TOSCANO, 60x60x2 cm (24"x24"x0.8")  
TURIN, ITALY



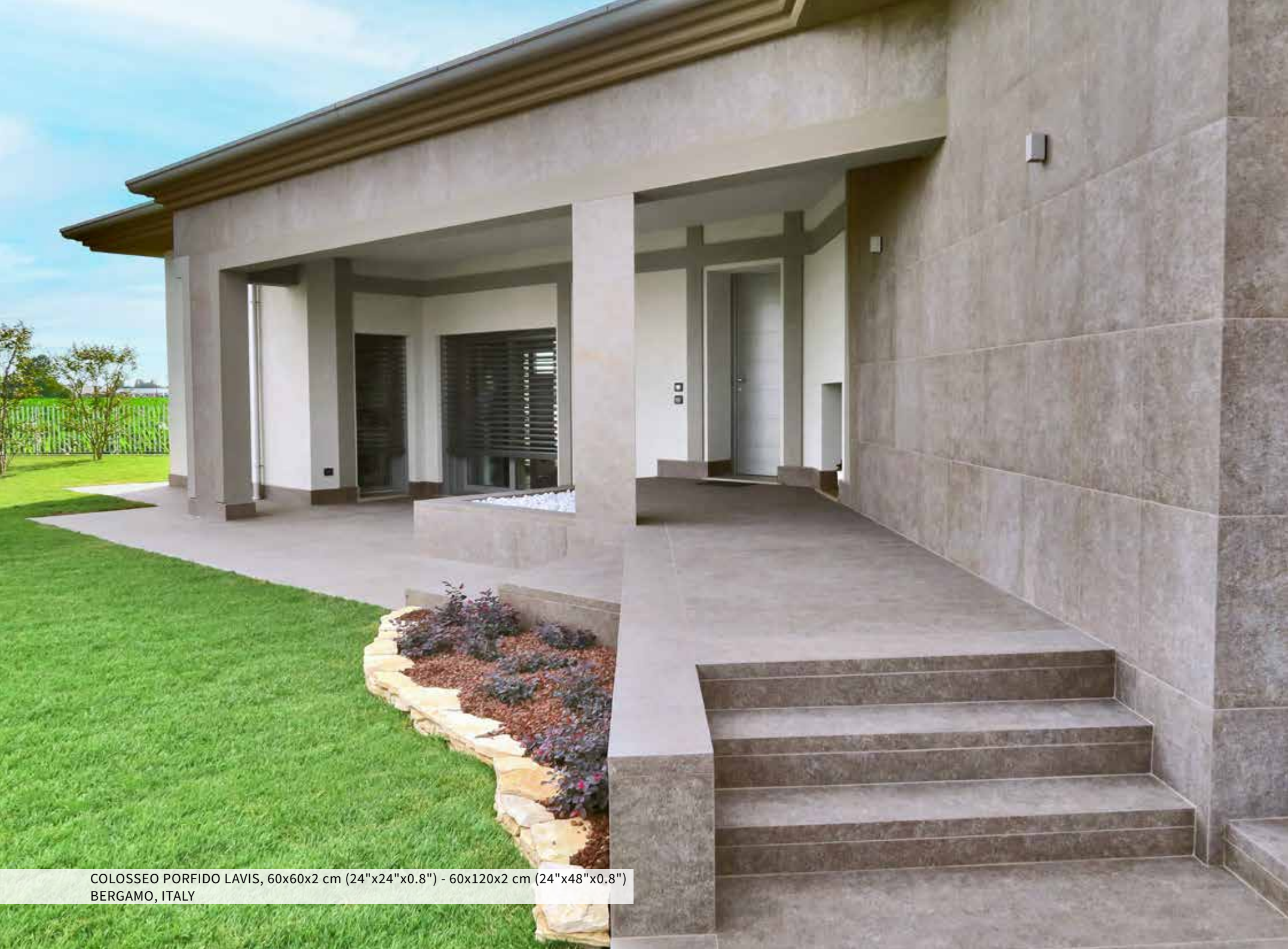

COLOSSEO PORFIDO LAVIS, 60x60x2 cm (24"x24"x0.8") - 60x120x2 cm (24"x48"x0.8")  
BERGAMO, ITALY



# 2 COLOSSEO PORFIDO LAVIS



000299



120x120x2 cm

000222



60x120x2 cm

011201



60x60x2 cm

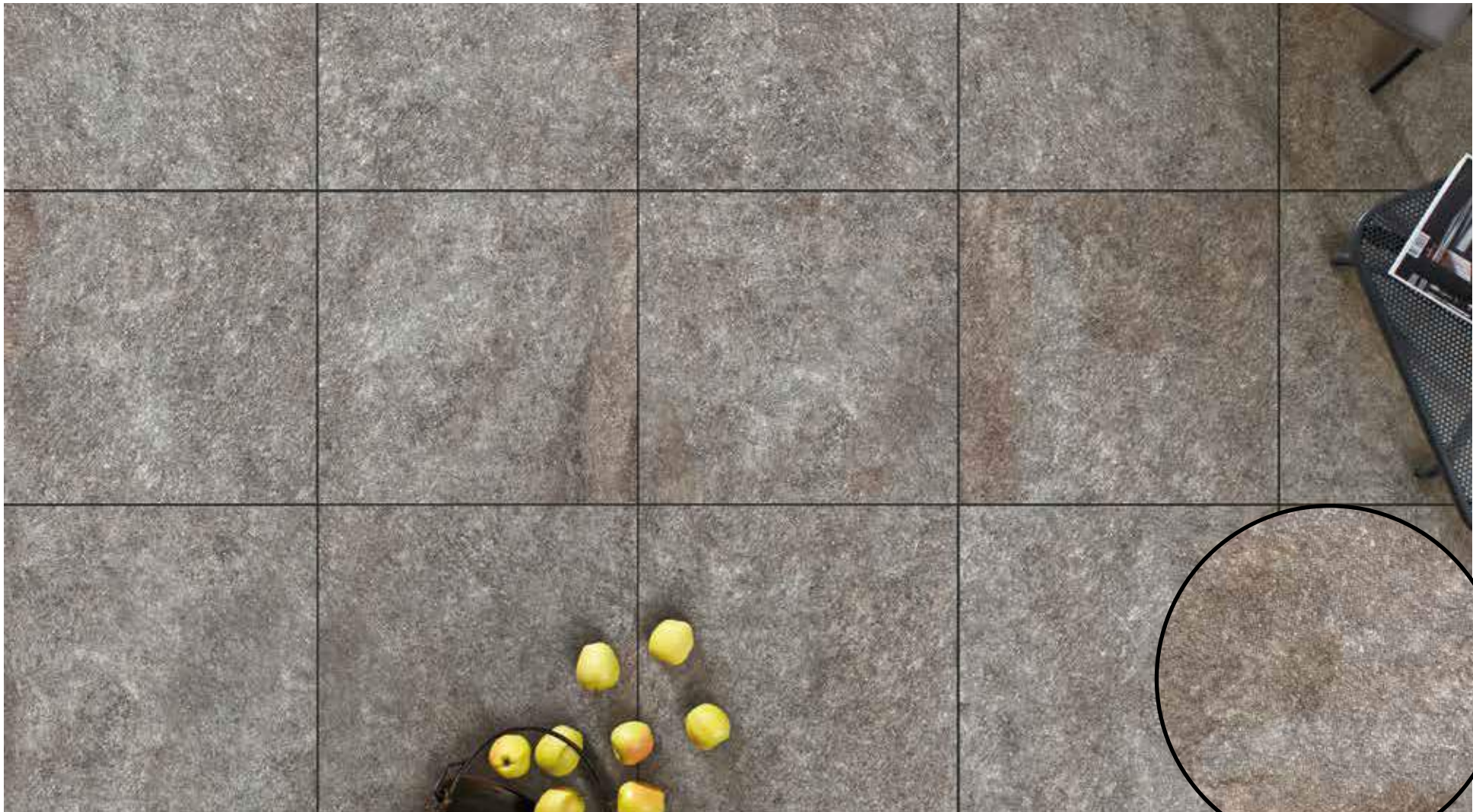
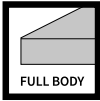

120x240x2cm (48"x96"x0.8") in the XXL section - 120x240x2cm nella sezione XXL - 120x240x2cm im Bereich XXL - 120x240x2cm dans la section XXL



2  
cm

# COLOSSEO QUARZITE WHITE

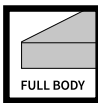

011701

60x60x2 cm





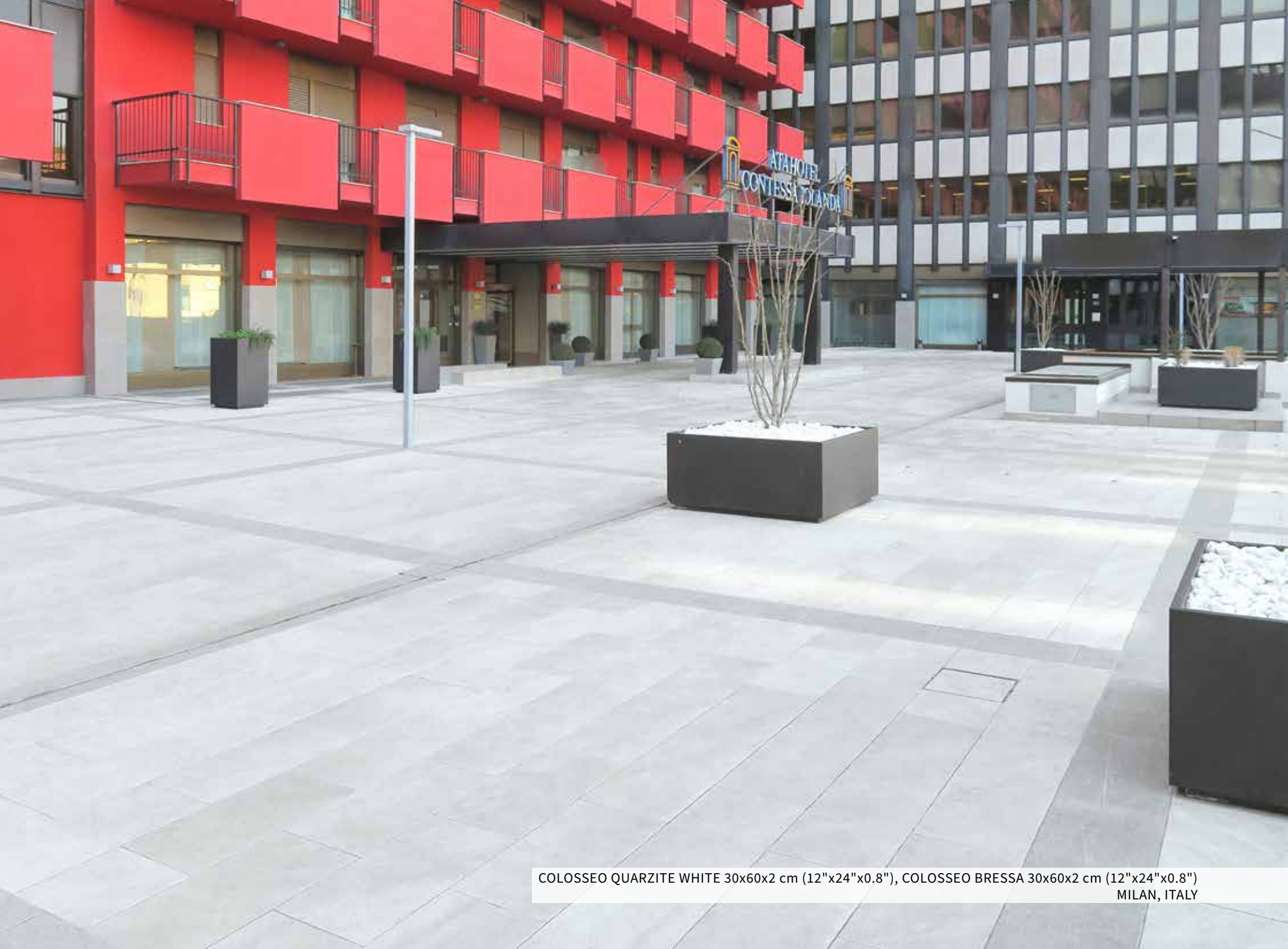

COLOSSEO QUARZITE WHITE 30x60x2 cm (12"x24"x0.8"), COLOSSEO BRESSA 30x60x2 cm (12"x24"x0.8")  
MILAN, ITALY



2  
cm

# COLOSSEO DORATO

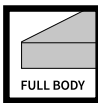

010401

60x60x2 cm

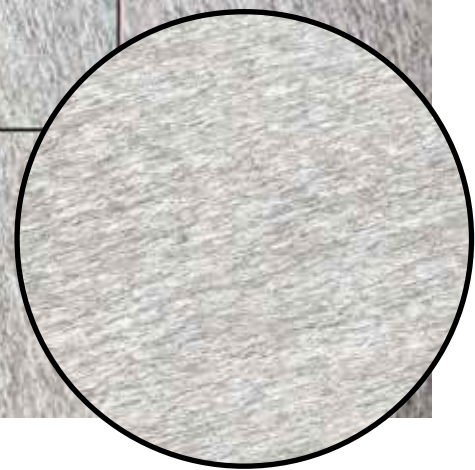



2  
cm

# COLOSSEO LUSERNA BAGNOLO

L'ALTRA<sup>®</sup>  
**PIETRA**  
THE HIGH QUALITY  
OUTDOOR PAVING



R11

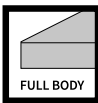

000301



120x120x2 cm

011101



60x60x2 cm



120x240x2cm (48"x96"x0.8") in the XXL section - 120x240x2cm nella sezione XXL - 120x240x2cm im Bereich XXL - 120x240x2cm dans la section XXL

L'ALTRA PIETRA



2  
cm

## COLOSSEO TIPOVALS

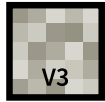

000297

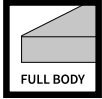

120x120x2 cm

011804

60x120x2 cm



011803

45x90x2 cm



011401

60x60x2 cm



120x240x2cm (48"x96"x0.8") in the XXL section - 120x240x2cm nella sezione XXL - 120x240x2cm im Bereich XXL - 120x240x2cm dans la section XXL



# 2 cm FORTEZZA SNOW ALPS

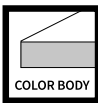

000615

60x120x2 cm

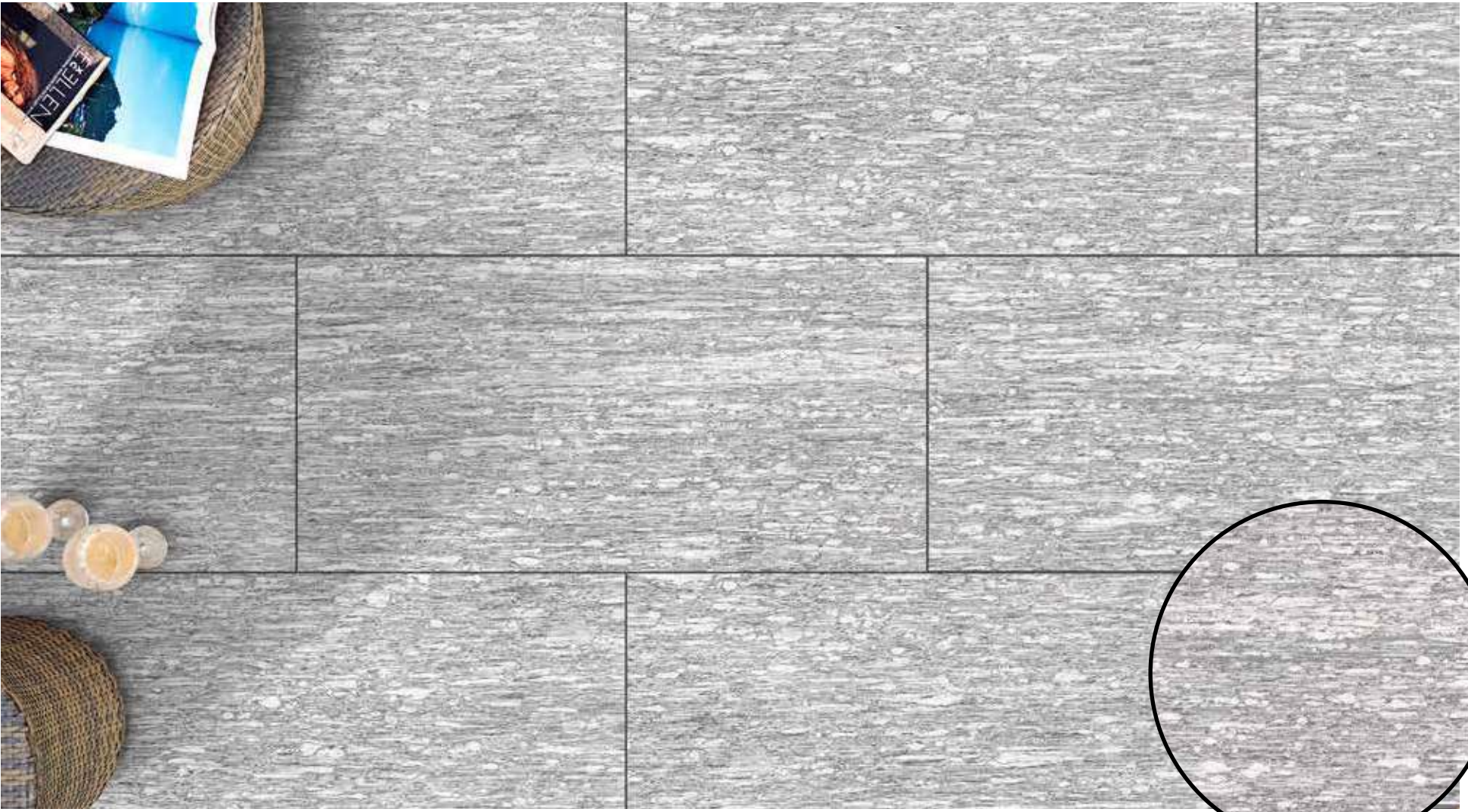



2  
cm

# FORTEZZA MONTORFANO

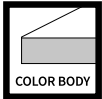
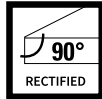

000484

60x120x2 cm



000478

60x60x2 cm



000560SNT



40x80x2 cm



000482

45x90x2 cm

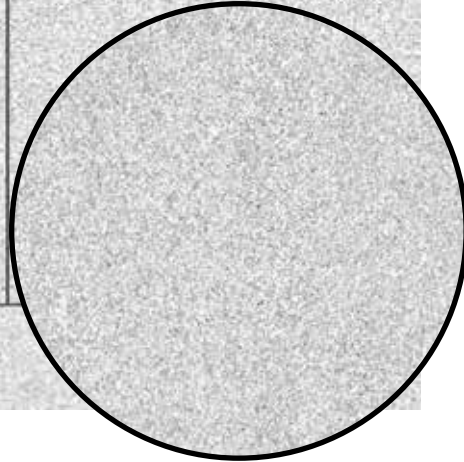



# 2 cm FORTEZZA DIORITE

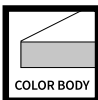

000485



60x120x2 cm

000479



60x60x2 cm

000559SNT

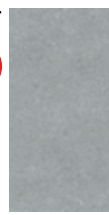

40x80x2 cm

000483

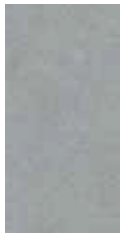

45x90x2 cm





# 2 cm FORTEZZA MAGGIA

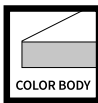

000481

50x100x2 cm





# 2 cm FORTEZZA BIASCA

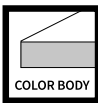

000480

50x100x2 cm

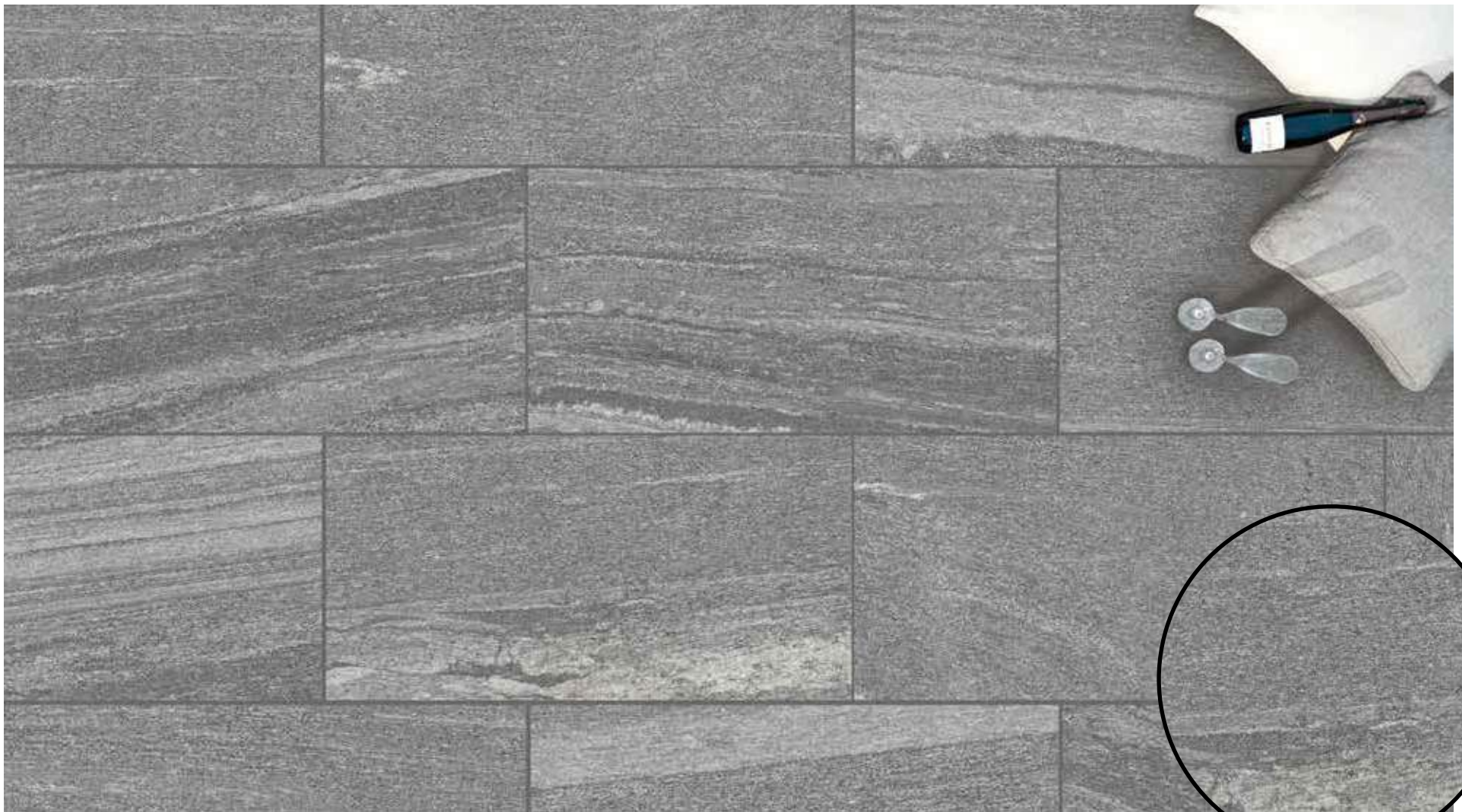

1 cm (0.4") R11 sizes in the section: - Formati da 1 cm R11 nella sezione: - Verfügbare Größen von 1 cm R11 im Bereich: - Tailles de 1 cm R11 dans la section: COMBINE Indoor & Outdoor





HARENA CALANCA LIGHT, 40x120x2 cm (16"x48"x0.8")  
BERGAMO, ITALY



# 2 HARENA CALANCA LIGHT

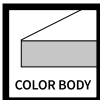

010702  
40x120x2 cm



000557SNT  
**NEW**  
40x80x2 cm



1 cm (0.4") R10 sizes in the section: - Formati da 1 cm R10 nella sezione: - Verfügbare Größen von 1 cm R10 im Bereich: - Tailles de 1 cm R10 dans la section: COMBINE Indoor & Outdoor



2  
cm

# HARENA CALANCA DARK



**R11**

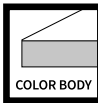

000558SNT

010802

40x120x2 cm



**NEW**

40x80x2 cm

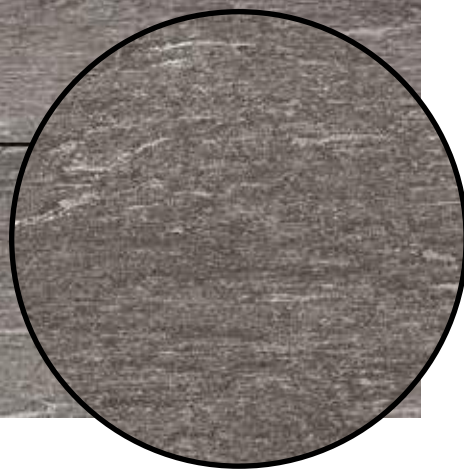

1 cm (0.4") R10 sizes in the section: - Formati da 1 cm R10 nella sezione: - Verfügbare Größen von 1 cm R10 im Bereich: - Tailles de 1 cm R10 dans la section: COMBINE Indoor & Outdoor





HARENA CALANCA DARK, 40x120x2 cm (16"x48"x0.8")  
MILAN, ITALY





HARENA SAND STONE BEIGE, 40x120x2 cm (16"x48"x0.8")  
BERGAMO, ITALY



# 2 HARENA SAND STONE BEIGE

L'ALTRA<sup>®</sup>  
**PIETRA**  
THE HIGH QUALITY  
OUTDOOR PAVING

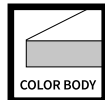

010902  
40x120x2 cm





# 2 HARENA ARDESIA

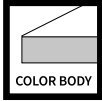
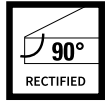
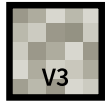

011002  
40x120x2 cm





# 2 TORRE QUARZITE GRIGIA

L'ALTRA<sup>®</sup>  
**PIETRA**  
THE HIGH QUALITY  
OUTDOOR PAVING

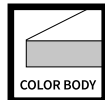

010408  
40x80x2 cm





2  
cm

# TORRE LUSERNA MISTA

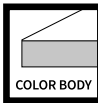

000792

NEW

40x80x2 cm





# 2 TORRE MOKA

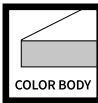

010208

40x80x2 cm





# 2 TORRE BIANCA

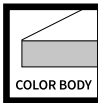

010308  
40x80x2 cm





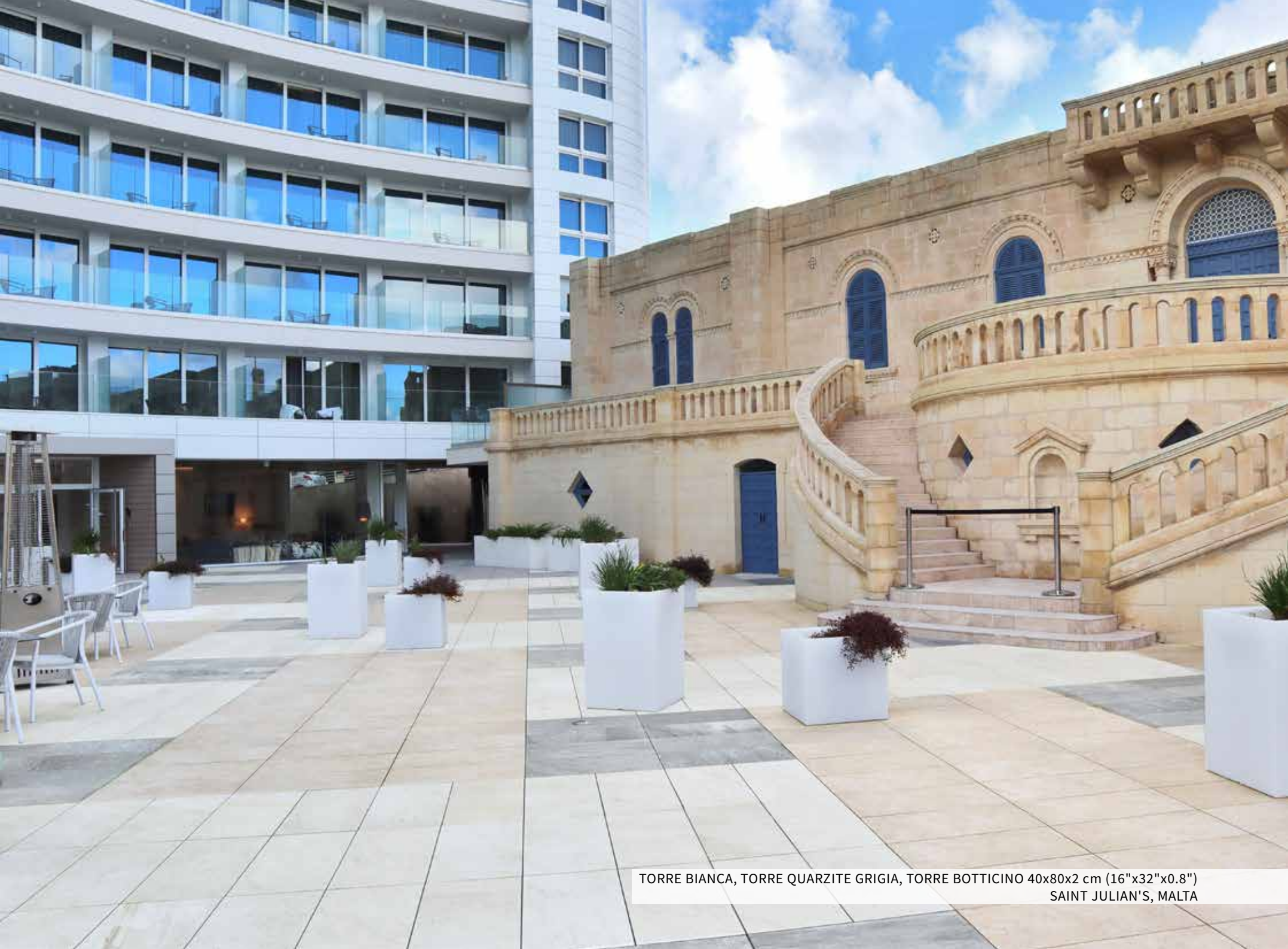

TORRE BIANCA, TORRE QUARZITE GRIGIA, TORRE BOTTICINO 40x80x2 cm (16"x32"x0.8")  
SAINT JULIAN'S, MALTA





TORRE BOTTICINO, 40x80x2 cm (16"x32"x0.8")  
MILAN, ITALY



# 2 TORRE BOTTICINO

L'ALTRA<sup>®</sup>  
**PIETRA**  
THE HIGH QUALITY  
OUTDOOR PAVING

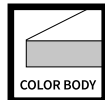
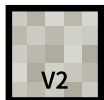

010108  
40x80x2 cm

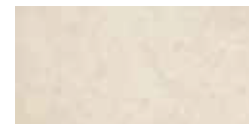



2  
cm

# DUOMO EVOLUTION SLATE



R11

000320

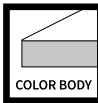

60x90x2 cm

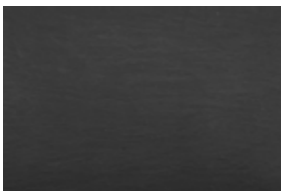

# 2 DUOMO MINT

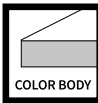
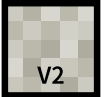

010509

60x90x2 cm





2  
cm

# DUOMO TRAVERTINO BEIGE

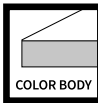

000319

60x90x2 cm



1 cm (0.4") R10 sizes in the section: - Formati da 1 cm R10 nella sezione: - Verfügbare Größen von 1 cm R10 im Bereich: - Tailles de 1 cm R10 dans la section: COMBINE Indoor & Outdoor



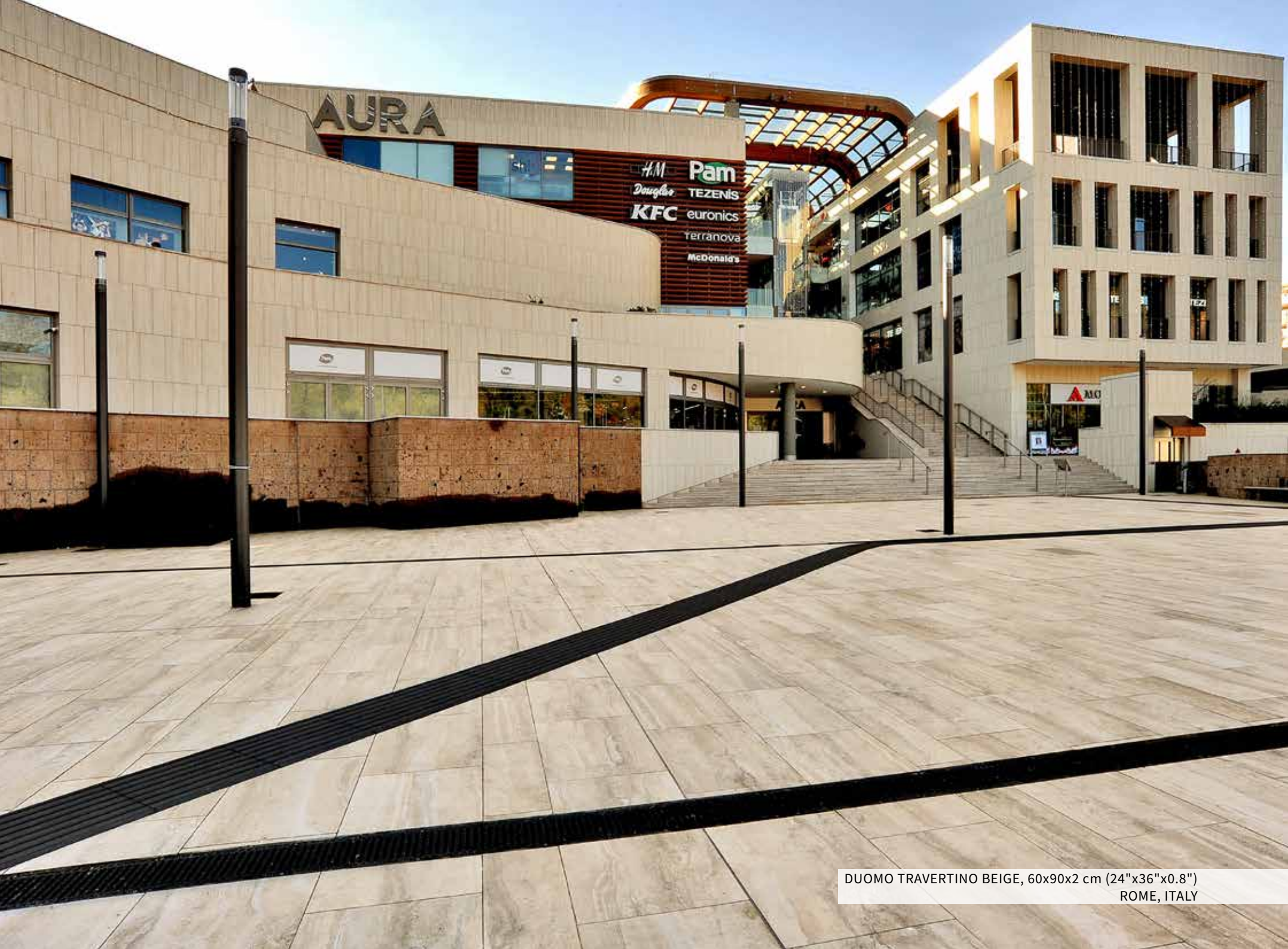

AURA

H&M Pam  
Douglas TEZENIS  
KFC euronics  
terranova  
McDonald's

DUOMO TRAVERTINO BEIGE, 60x90x2 cm (24"x36"x0.8")  
ROME, ITALY





DUOMO CARRARA, 60x90x2 cm (24"x36"x0.8")  
PADUA, ITALY

# 2 DUOMO CARRARA



000504

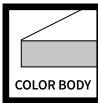

60x90x2 cm





2  
cm

# DUOMO VALSTONE LIGHT

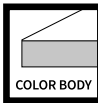

000395

60x90x2 cm



# 2 DUOMO VALSTONE DARK



000396

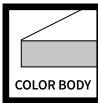

60x90x2 cm







DUOMO PERLA, 60x90x2 cm (24"x36"x0.8")  
HUSTON, USA

# 2 DUOMO PERLA



010109

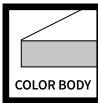

60x90x2 cm

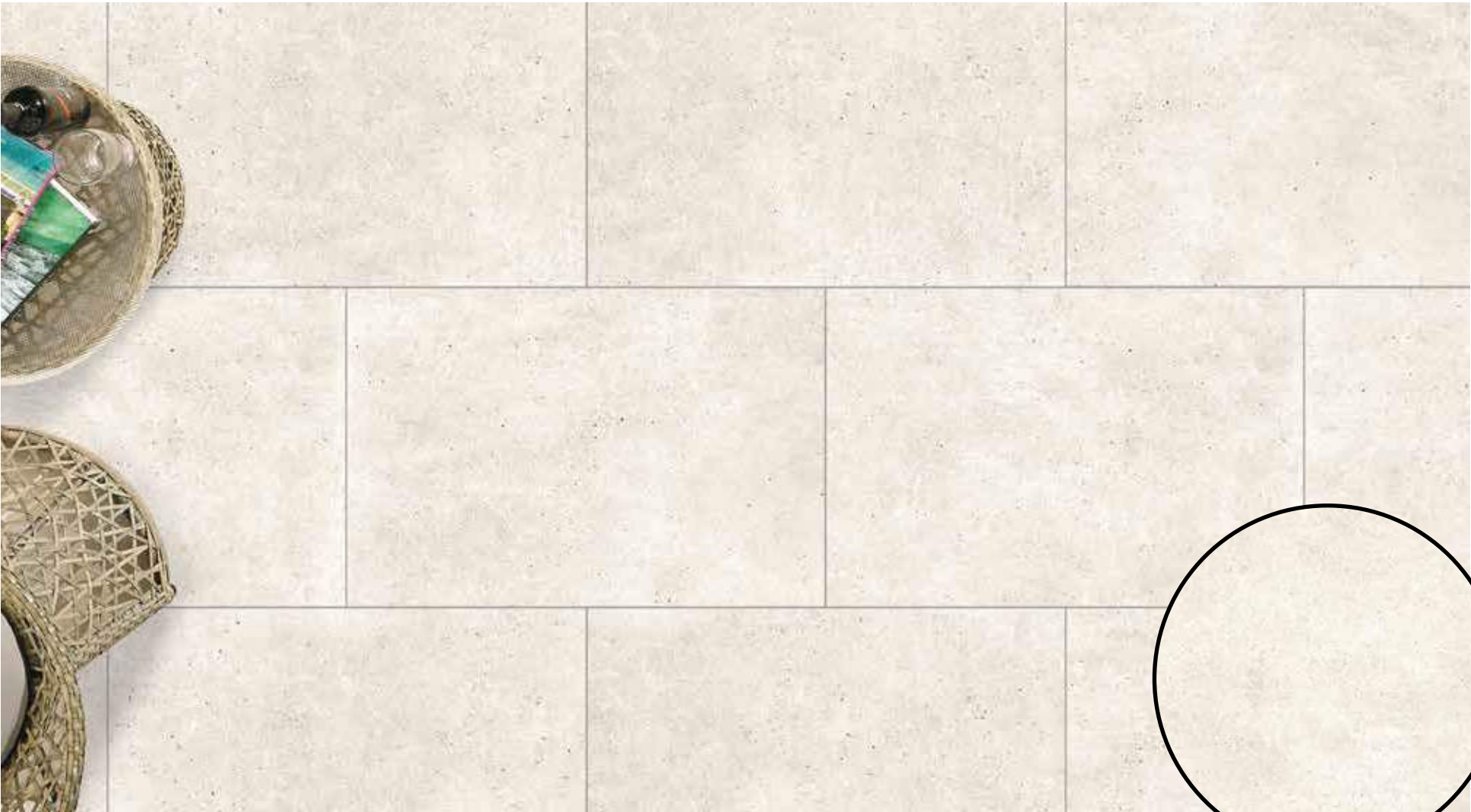

1 cm (0.4") R10 sizes in the section: - Formati da 1 cm R10 nella sezione: - Verfügbare Größen von 1 cm R10 im Bereich: - Tailles de 1 cm R10 dans la section: COMBINE Indoor & Outdoor



# 2 DUOMO SABBIA

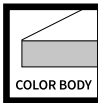

010209

60x90x2 cm



1 cm (0.4") R10 sizes in the section: - Formati da 1 cm R10 nella sezione: - Verfügbare Größen von 1 cm R10 im Bereich: - Tailles de 1 cm R10 dans la section: COMBINE Indoor & Outdoor

# 2 DUOMO PIETRA

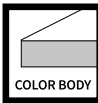

010409

60x90x2 cm



1 cm (0.4") R10 sizes in the section: - Formati da 1 cm R10 nella sezione: - Verfügbare Größen von 1 cm R10 im Bereich: - Tailles de 1 cm R10 dans la section: COMBINE Indoor & Outdoor



# 2 DUOMO OMBRA

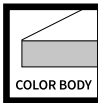

010309

60x90x2 cm



1 cm (0.4") R10 sizes in the section: - Formati da 1 cm R10 nella sezione: - Verfügbare Größen von 1 cm R10 im Bereich: - Tailles de 1 cm R10 dans la section: COMBINE Indoor & Outdoor

# 2 DUOMO BLUESTONE GREY

L'ALTRA<sup>®</sup>  
**PIETRA**  
THE HIGH QUALITY  
OUTDOOR PAVING



010709

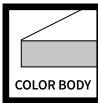

60x90x2 cm



L'ALTRA PIETRA



2  
cm

# DUOMO BLUESTONE NOIR

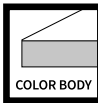

010609

60x90x2 cm





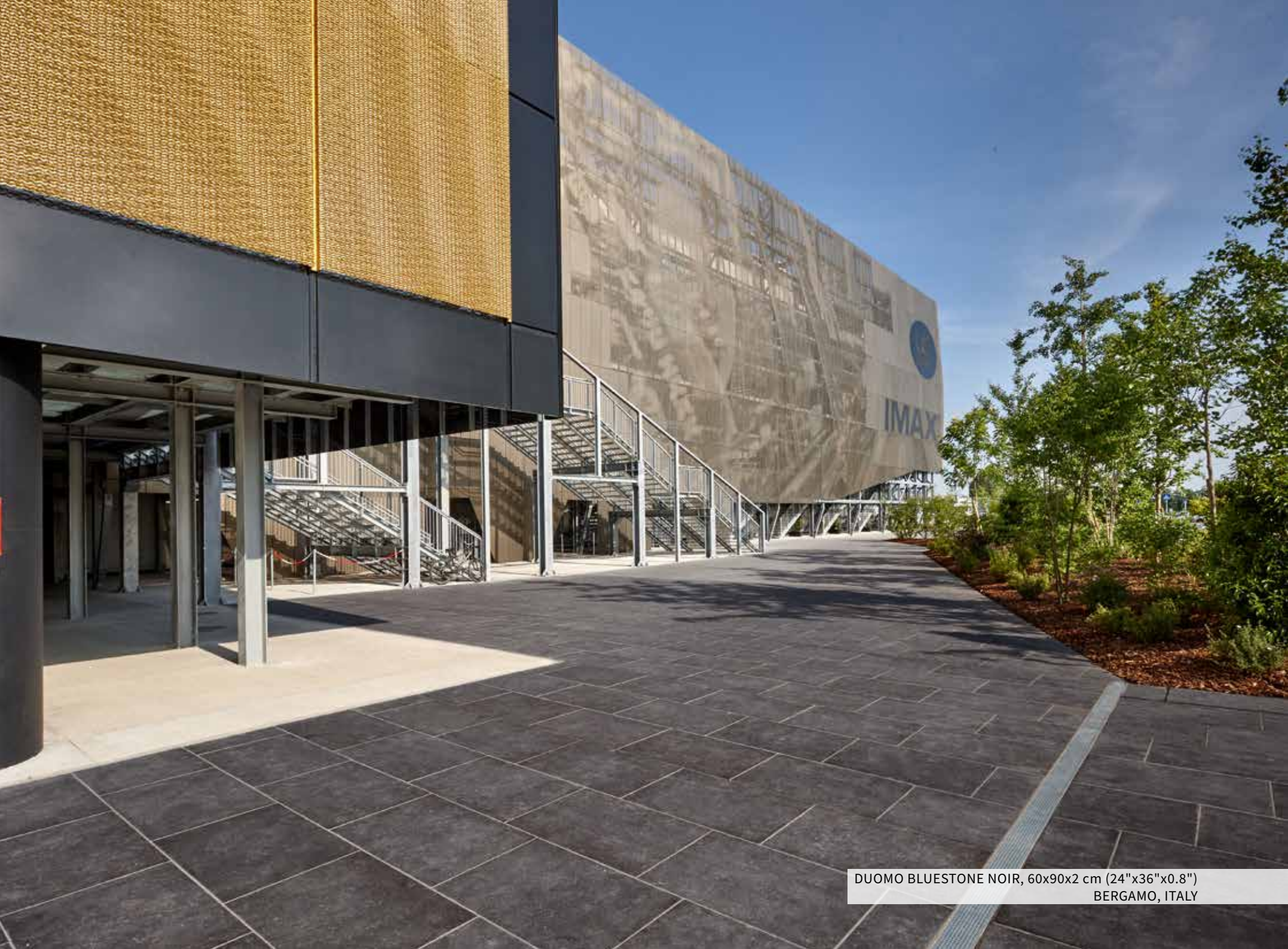

DUOMO BLUESTONE NOIR, 60x90x2 cm (24"x36"x0.8")  
BERGAMO, ITALY





CATTEDRALE CEMENTO, 90x90x2 cm (36"x36"x0.8")  
HERZLIYA, ISRAEL

# 2 CATTEDRALE CEMENTO

L'ALTRA<sup>®</sup>  
**PIETRA**  
THE HIGH QUALITY  
OUTDOOR PAVING

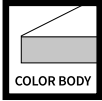

010511

90x90x2 cm





2  
cm

# CATTEDRALE AVORIO

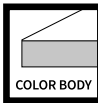

010411

90x90x2 cm

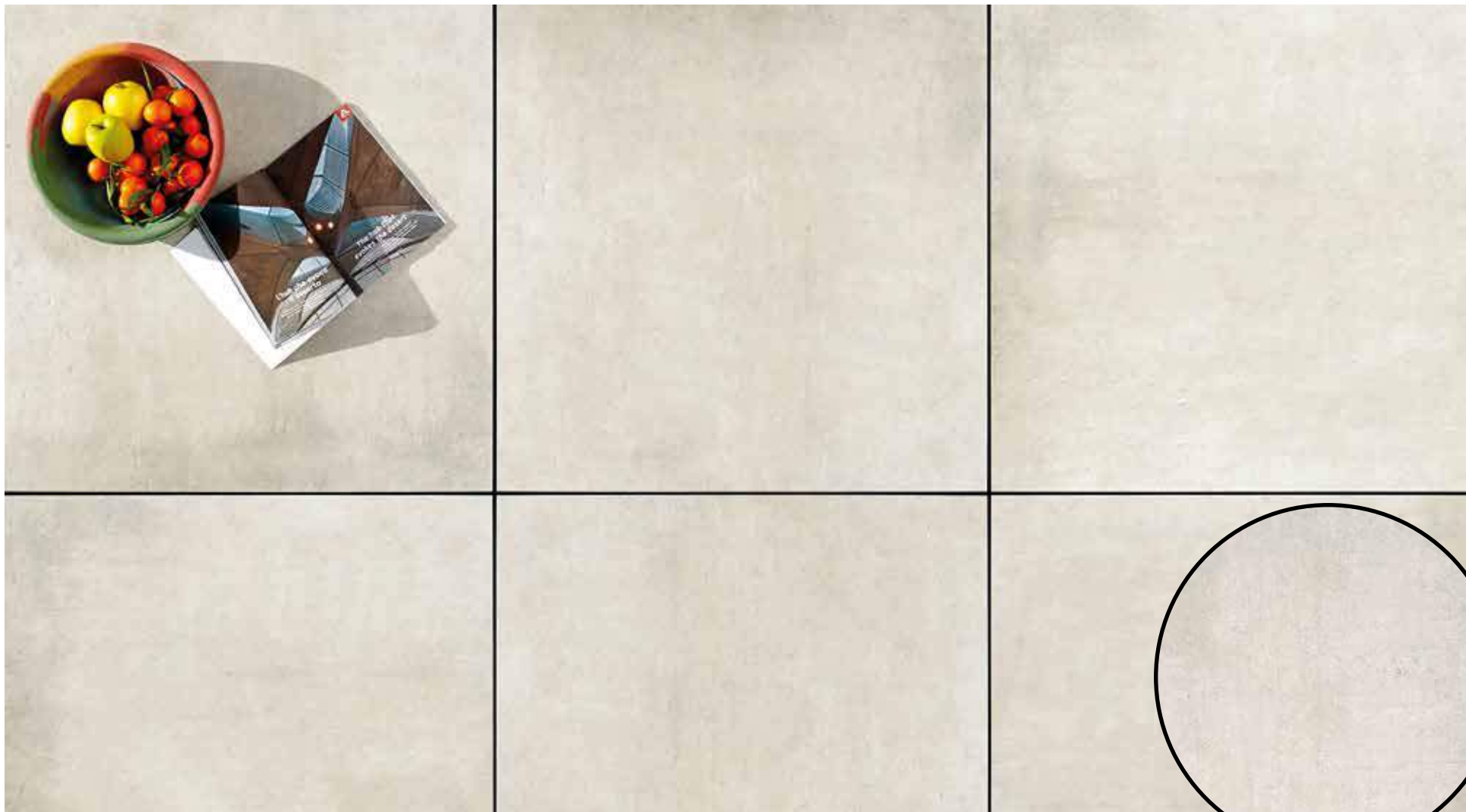



CATTEDRALE AVORIO, 90x90x2 cm (36"x36"x0.8")  
BRESCIA, ITALY



2  
cm

# CATTEDRALE GREY

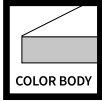
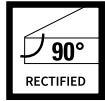
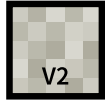

010111

90x90x2 cm



2  
cm

# CATTEDRALE ANTRAZYT

L'ALTRA<sup>®</sup>  
**PIETRA**  
THE HIGH QUALITY  
OUTDOOR PAVING

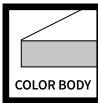

010211

90x90x2 cm

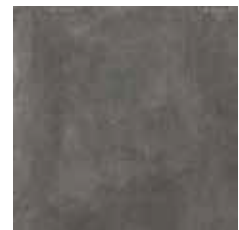

L'ALTRA PIETRA



2  
cm

# CATTEDRALE MOKA

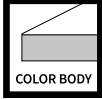
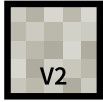

010311

90x90x2 cm



# 2 cm MUSEO ARDESIA NERA

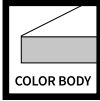
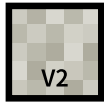

000474

40x120x2 cm



000988



60x90x2 cm



012401

60x60x2 cm





2  
cm

# MUSEO ARDESIA BEIGE

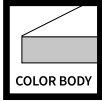
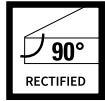
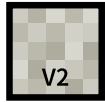

001006



60x90x2 cm





MUSEO ARDESIA BEIGE, 60x90x2 cm (24"x36"x0.8")  
BRESCIA, ITALY



2  
cm

# MUSEO ARDESIA GRIGIA

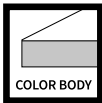
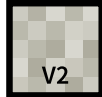

000795  
40x120x2 cm



000989  
NEW  
60x90x2 cm



012501  
60x60x2 cm

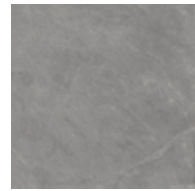

# 2 cm MUSEO PIERRE BLUE GREY

L'ALTRA<sup>®</sup>  
**PIETRA**  
THE HIGH QUALITY  
OUTDOOR PAVING

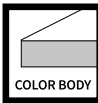
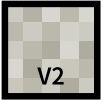

012301SF

60x60x2 cm





2  
cm

# MUSEO PIERRE BLUE NOIR

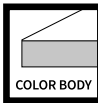

012201

60x60x2 cm



# 2 CASTELLO BEIGE

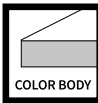

000212



80x80x2 cm

010101



60x60x2 cm

010107



50x100x2 cm





# 2 cm CASTELLO GREY



000213



80x80x2 cm

010201

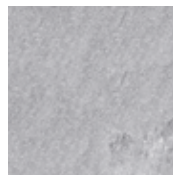

60x60x2 cm

010207

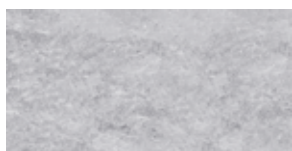

50x100x2 cm

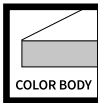





CASTELLO GREY, 60x60x2 cm (24"x24"x0.8")  
MIAMI, USA



2  
cm

# CASTELLO ANTRAZYT

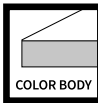

000214



80x80x2 cm

010301



60x60x2 cm

010307



50x100x2 cm



# 2 MODERN CONCRETE BEIGE

L'ALTRA<sup>®</sup>  
**PIETRA**  
THE HIGH QUALITY  
OUTDOOR PAVING

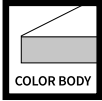

000852HRNSF



100x100x2 cm





2  
cm

# MODERN CONCRETE GREY

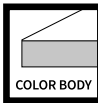

000790HRNSF



100x100x2 cm

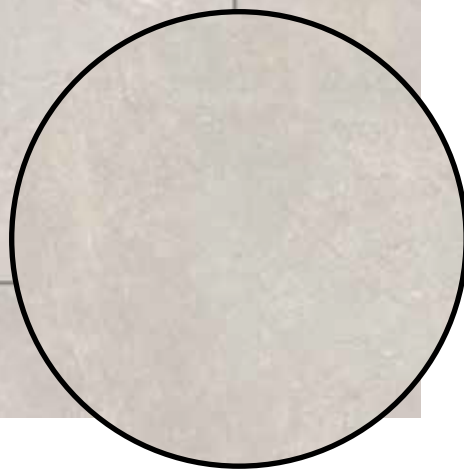



MODERN CONCRETE GREY, 100x100x2 cm (40"x40"x0.8")



2  
cm

# MODERN CONCRETE ANTRAZYT

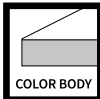
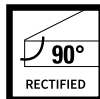
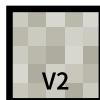

000853HRNSF



100x100x2 cm



# 2 TEMPIO KANDLA BEIGE

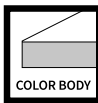

000928

NEW

60x90x2 cm



000933

NEW

60x60x2 cm

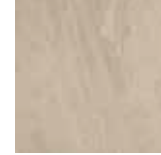

000949

NEW

40x80x2 cm

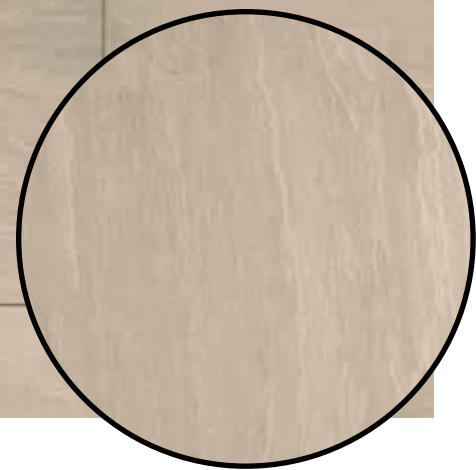



2  
cm

# TEMPIO KANDLA ANTRACITE

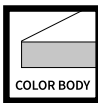

000927

NEW

60x90x2 cm



000932

NEW

60x60x2 cm

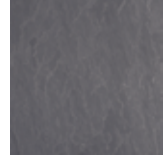

000948

NEW

40x80x2 cm



# 2 TEMPIO KANDLA GREY

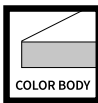

000926



60x90x2 cm



000931



60x60x2 cm



000947



40x80x2 cm





# 2 TEMPIO MODAK

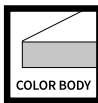

000930



60x90x2 cm



000951



40x80x2 cm



# 2 TEMPIO BUFF

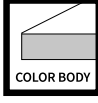
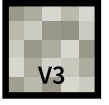

000929

NEW

60x90x2 cm



001002

NEW

60x60x2 cm

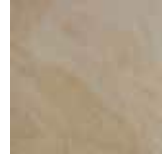

000950

NEW

40x80x2 cm

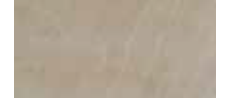



# MODULI

Različiti formati, velike mogućnosti. Napravite unikatno popločanje, odabereti željenu nijansu.

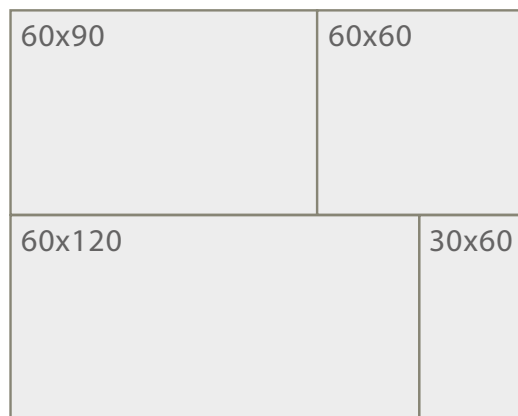

## MODUL 1

60x120 = 40%  
60x60 = 20%  
60x90 + 30x60 = 40%

Dostupno u svim nijansama:  
60x120

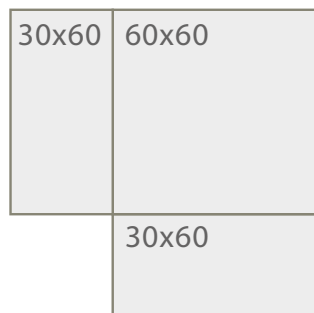

## MODUL 2

60x60 = 50%  
30x60 = 50%

Dostupno u svim nijansama:  
60x60, 60x90

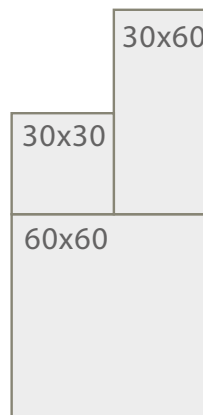
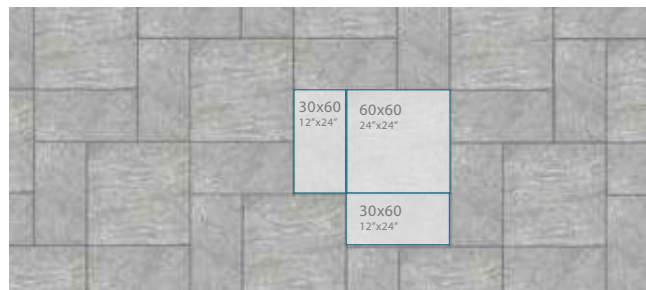

## MODUL 3

60x60 = 57%  
30x30 = 14%  
30x60 = 29%

Dostupno u svim nijansama:  
60x60, 60x90

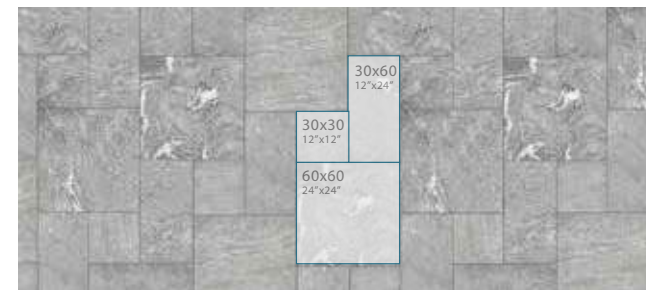

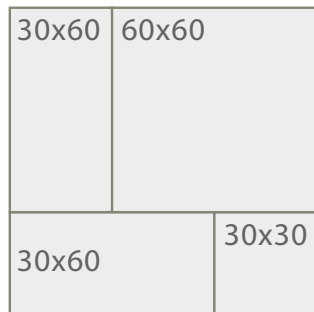

#### MODUL 4

60x60 = 44%  
 30x60 = 45%  
 30x30 = 11%

Dostupno u svim nijansama:  
 60x60, 60x90, 90x90

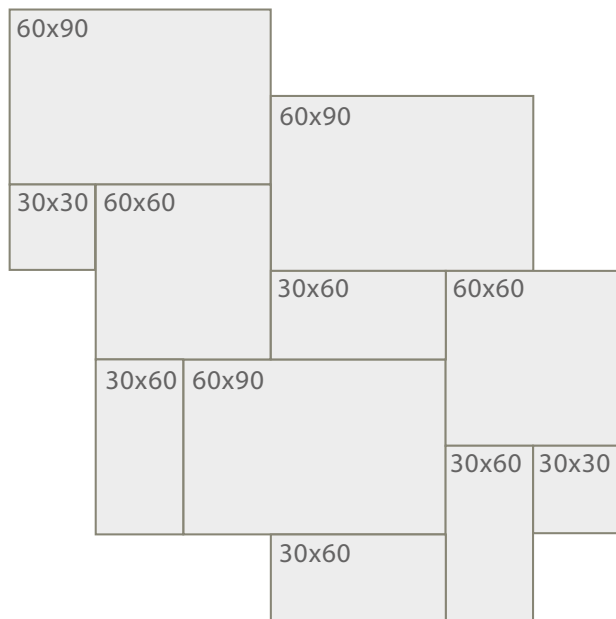

#### MODUL 5

90x60 = 56%  
 60x60 = 25%  
 30x60 = 13%  
 30x30 = 6%

Dostupno u svim nijansama:  
 60x90, 60x120

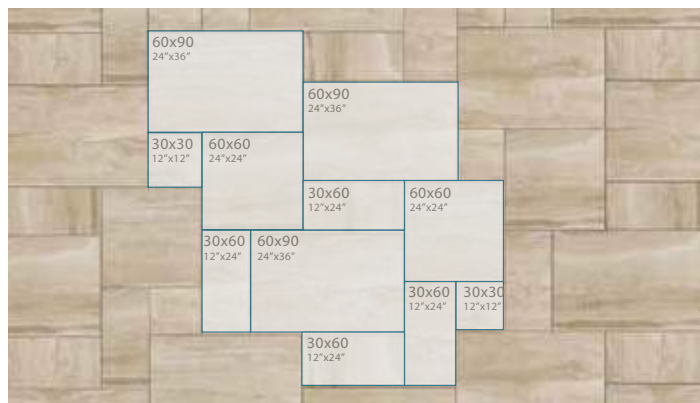

DUOMO TRAVERTINO, BEIGE MODULE 5





# SPECIJALNI FORMATI

TORRE QUARZITE GRIGIA, 20x20x2 cm (8"x8"x0.8"),  
SAINT JULIAN'S, MALTA



Napravite unikatno popločanje, odaberite željenu nijansu.

60x60



30x60

30x30

40x80



40x40

20x80

60x90



30x90

45x60

40x120



20x120

40x60

COLOSSEO FIORA 30x60x2 cm (12"x24"x0.8")  
SAN MARINO



COLOSSEO SILVERGRAU 30x60x2 cm (12"x24"x0.8")  
BERGAMO, ITALY



HARENA CALANCA LIGHT, VARIOUS SIZES  
MADONNA DI CAMPIGLIO, ITALY



COLOSSEO GRIGIONI 30x60x2 cm (12"x24"x0.8")  
ASPEN, USA





# SPECIJALNI ELEMENTI

Sve nijanse i željeni formati su dostupni po zahtevu. Specijalni elementi se proizvode od standardnih formata iz kataloga, uzimajući u obzir maksimalni format iste ploče.



L - U POKRIVNA PLOČICA



BLOK STEPENIK



BULLNOSE PLOČICA



IZDIGNUTI STEPENIK





REŠETKA



ŽARDINJERA



KLUPA



STUBNI STO



ŽARDINJERA

L - U PLOČICA

USECI

BULLNOSE PLOČICA

BLOK STEPENIK

KLUPA



L - U COPING - COPERTINA L - U - ABDECKPLATT L - U - COUVERTINE L - U



L COPING - COPERTINA L - ABDECKPLATT L - COUVERTINE L



BLOCK STEP - GRADONE - BLOCKSTUFE - MARCHE BLOC

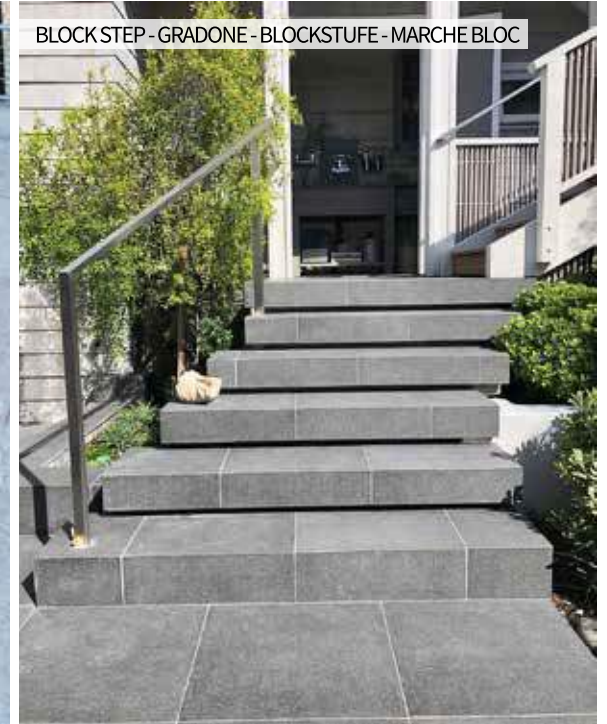

L COPING - COPERTINA L - ABDECKPLATT L - COUVERTINE L



BULLNOSE - BORDO TORO - ABGERUNDETE KANTE BORDS ARRONDIS



FLOWERPOT - FIORIERA - BLUMENTOPF - JARDINIÈRE





FLOWERPOT - FIORIERA - BLUMENTOPF - JARDINIÈRE



L COPING - COPERTINA L - ABDECKPLATT L - COUVERTINE L



BULLNOSE - BORDO TORO - ABGERUNDETE KANTE - BORDSARRONDIS



L COPING - COPERTINA L - ABDECKPLATT L - COUVERTINE L



BULLNOSE - BORDO TORO - ABGERUNDETE KANTE - BORDSARRONDIS

L COPING - COPERTINA L - ABDECKPLATT L - COUVERTINE L



BULLNOSE - BORDO TORO - ABGERUNDETE KANTE - BORDSARRONDIS



GRID - GRIGLIA - GITTER - GRILLE

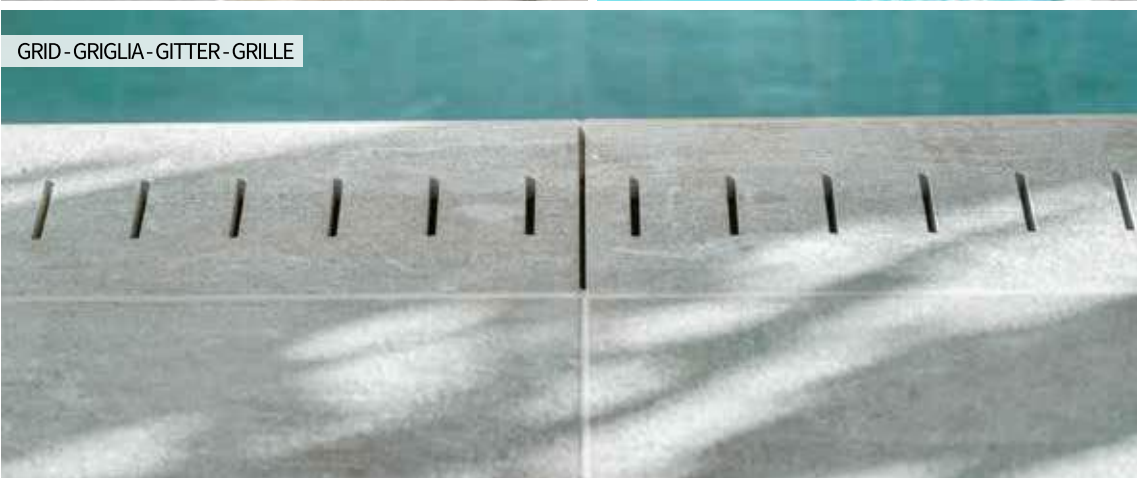



# SPOLJNI NAMEŠTAJ

Novi način spoljnog uređenja: saksije, vaze i klupe od sinterovanog kamena za parkove, terase, bašte, dvorišta i trgove. Kombinacijom ovih elemenata postiže se modularni sistem od proizvoda u istoj nijansi i materijalu.

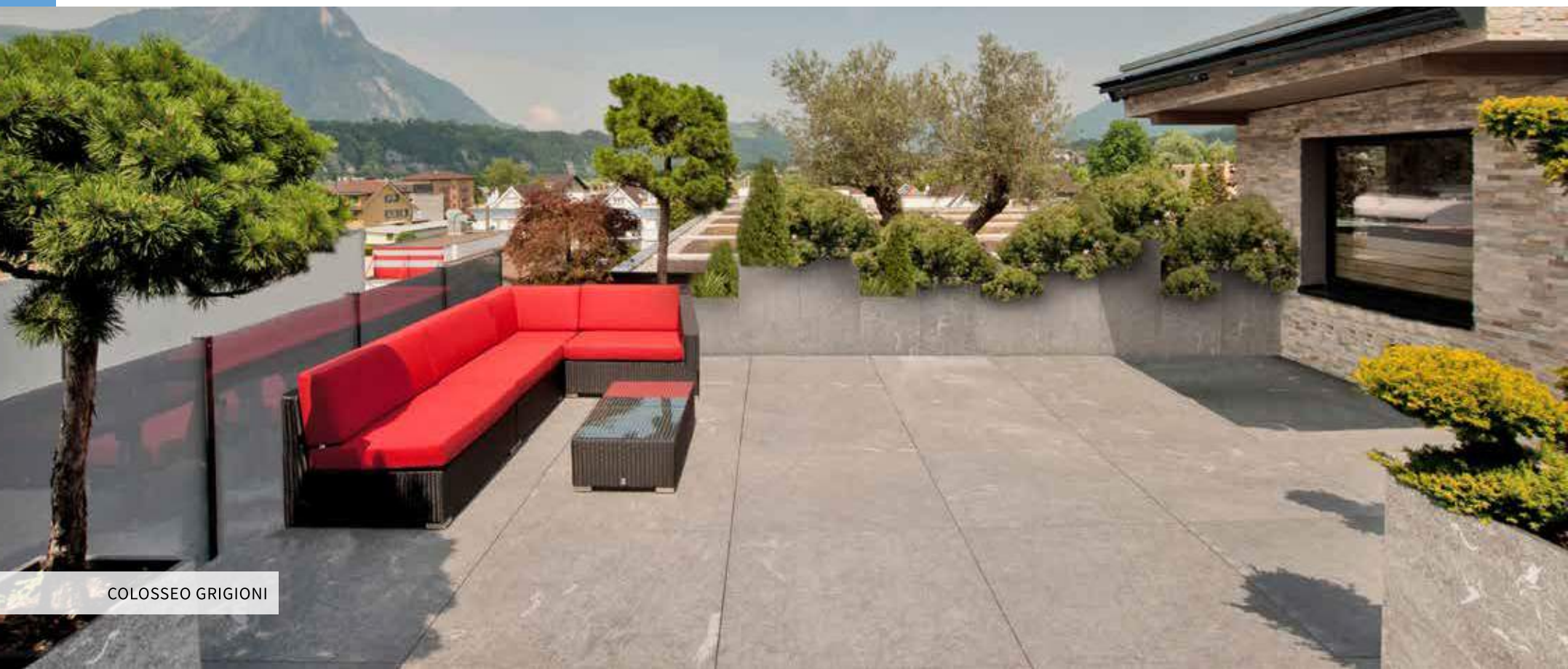



## ŽARDINJERE

Proizvodnja žardinjera je moguća u bilo kojoj veličini, obliku i nijansi, za čiju izradu se koriste dostupni formati ploča.



## KLUPE

Klupe mogu biti proizvedene u nijansi i veličini po želji.

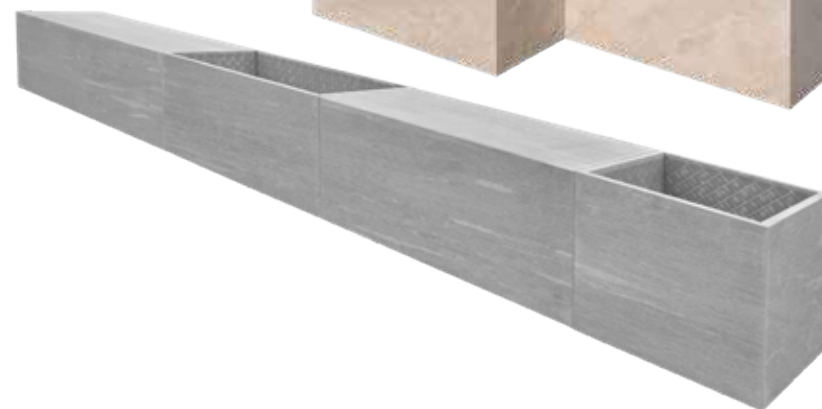
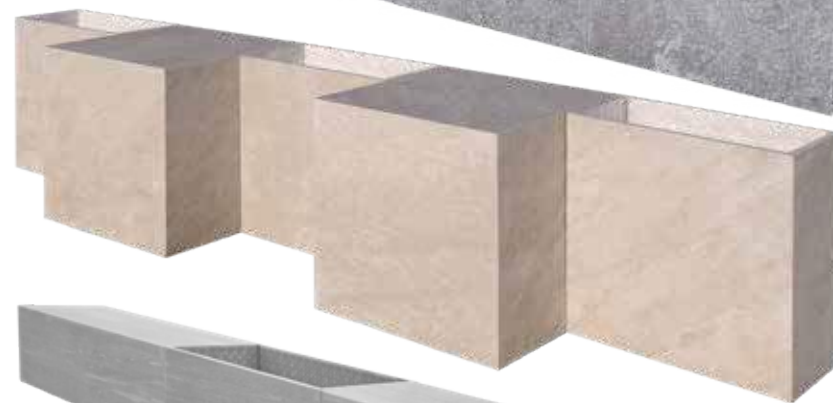



# UGRADNJA SINTEROVANOG KAMENA

SUVO POLAGANJE NA TRAVU



SUVO POLAGANJE NA PESAK/ŠLJUNAK



POLAGANJE SA LEPKOM PREKO KOŠULJICE



POLAGANJE NA MEŠAVINU CEMENTA I MOKROG PESKA



IZDIGNUTO POSTAVLJANJE NA NOSAČE



POSTAVLJANJE EASY PAVING METODOM



POSTAVLJANJE VENTILISANIH FASADA



# SUVO POLAGANJE NA TRAVU



## MESTA PRIMENE

Kolski prilazi  
Rezidencijalna područja  
Komerцијална područja  
Terase  
Bašte i dvorišta

## PREDNOSTI

Jednostavno za postavljanje  
Drenažna površina  
Lak za održavanje  
Za višekratnu upotrebu i  
jednostavan za zamenu



Na javnim površinama ili privatnim dvorištima, ploče mogu biti postavljene direktno na travu bez upotrebe lepka. Ovakav način polaganja nudi opciju da ih u bilo kom trenutku možete ukloniti i ponovo ih upotrebiti kada odlučite. Suvo polaganje ne zahteva poseban način ugradnje i ploče su odmah spremne za hodaње.



DRIVE-OVER FOR SLABS WITH 3, 5 CM (1.2", 2") THICKNESS





**VIDEO**



# SUVO POLAGANJE NA PESAK ILI ŠLJUNAK

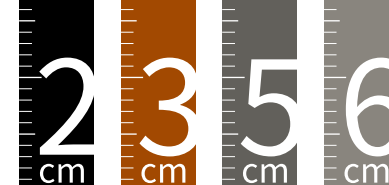

## PRIMER POLAGANJA NA ZEMLJU

- A - Ploča sa krstićima
- B - Pesak/šljunak
- C - Geo-tekstil
- D - Drenažni sloj
- E - Zemlja

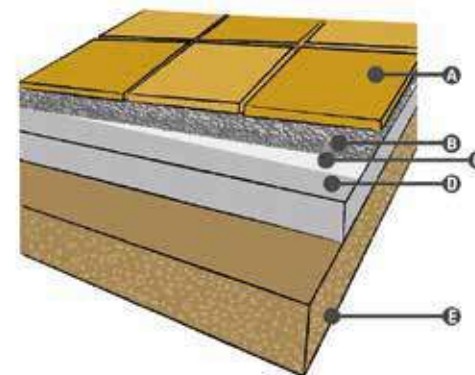

## PRIMER POLAGANJA NA ČVRSTU PODLOGU

- A - Ploča sa krstićima
- B - Sloj šljunka
- C - Separacioni sloj
- D - Termoizolacioni sloj
- E - Parna barijera
- F - Hidroizolacioni sloj
- G - Košuljica
- H - Pod

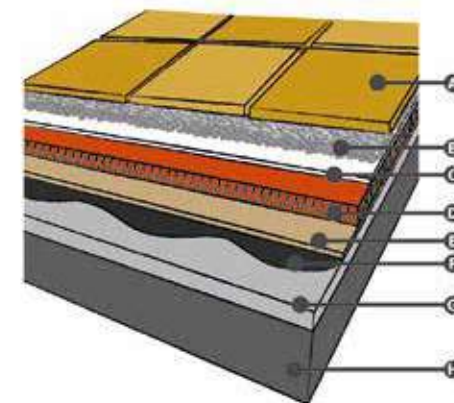

Ploče se mogu polagati na suvo, bez upotrebe lepka.  
Ploče se lako nivelišu preko peska/šljunka i odmah su spremne za hodanje. Ovaj način polaganja dozvoljava korisnicima da promene popločanje u bilo kom trenutku ili da koriste isti materijal nekoliko puta, na različitim lokacijama.



DRIVE-OVER FOR SLABS WITH 3, 5, 6 CM (1.2", 2", 2.4") THICKNESS





## PRIMER POLAGANJA 6cm

- A - 6 cm
- B - Pesak/šljunak
- C - Sloj košuljice sa armaturom
- D - Tvrdi sloj
- E - Zemlja

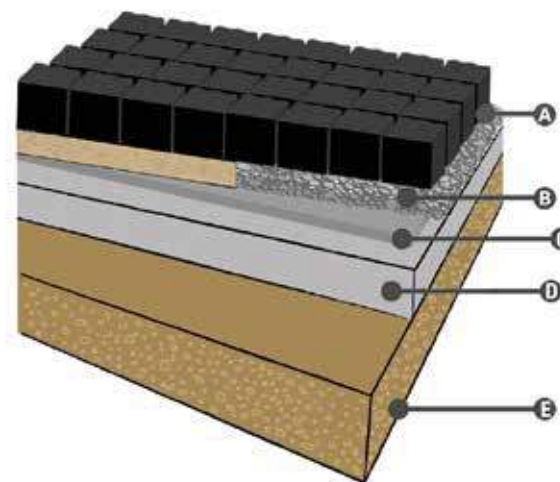

## MESTA PRIMENE

- Kolski prilazi
- Rezidancijalna područja
- Komercijalna područja
- Terase
- Bašte i dvorišta

## PREDNOSTI

- Jednostavno za postavljanje
- Drenažna površina
- Lak za održavanje
- Za višekratnu upotrebu i jednostavan za zamenu





**VIDEO**



# POLAGANJE SA LEPKOM PREKO KOŠULJICE

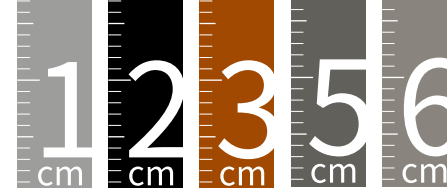

## MESTA PRIMENE

Kolski prilazi  
Površine oko bazena  
Terase  
Parking površine  
Rezidencijalna područja  
Komerrijalna područja  
Spoljno stepenište  
Garažne rampe

## PREDNOSTI

Maksimalna stabilnost tokom vremena  
Idealno za kolske prilaze  
Idealno za područja sa visokom frekvencijom pešaka



Napredne tehničke karakteristike sinterovanog kamena u kombinaciji sa tehnikom postavljanja koristeći lepak preko košuljice omogućava korisnicima da kreiraju savršeno stabilnu i izdržljivu površinu.

Kroz ovakav način postavljanja ploče mogu da izdrže težinu vozila u pokretu kao i parkiranih vozila.

Idealno je za visokofrekventna područja, posebno za trgove ili rampe.

Diletacije su neophodne a za spojeve koristiti fugu koja je na cementnoj bazi.



DRIVE-OVER FOR SLABS WITH 2, 3, 5, 6 CM (0.8", 1.2", 2", 2.4") THICKNESS





### PRIMER POLAGANJA NA ZEMLJU

- A - Ploča postavljena sa lepkom
- B - Nivelirajuća cementna košuljica (po potrebi sa armaturnom mrežom)
- C - Ojačani sloj
- D - Cementna košuljica
- E - Rastresiti sloj šljunka
- F - Zemlja

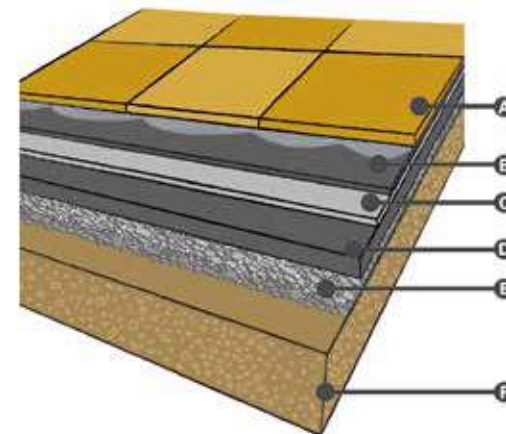

### PRIMER POLAGANJA NA KOŠULJICU

- A - Ploča
- B - Lepak
- C - Nivelirajuća cementna košuljica (po potrebi sa armaturnom mrežom)
- D - Strukturna košuljica - beton

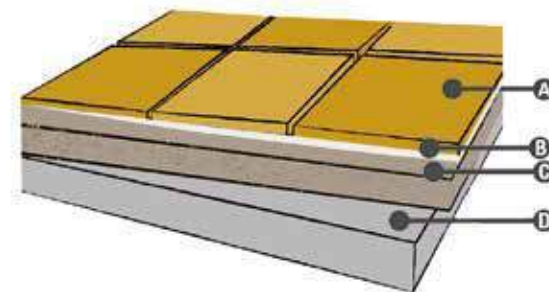

Rešenja za polaganje su ilustrativne prirode.



**VIDEO**



# POLAGANJE NA MEŠAVINU CEMENTA I MOKROG PESKA

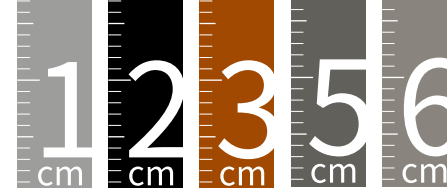

## MESTA PRIMENE

Kolski prilazi  
Površine oko bazena  
Terase  
Parking površine  
Rezidencijalni objekti  
Komercijalni objekti  
Garažne rampe

## PREDNOSTI

Maksimalna stabilnost tokom vremena  
Idealno za područja sa visokom frekvencijom pešaka

Ploče se polažu na bazu od mešavine peska i cementa. Ova tehnika omogućava dugoročnu stabilnost ploča i pogodna je za vozila. Takođe dozvoljava direktno polaganje ploča na zemlju uz uštedu na materijalu za nivelisanje. Diletacije su neophodne a za spojeve koristiti fugu koja je na cementnoj bazi.



## PRIMER POLAGANJA NA KOŠULJICU

- A - Ploča
- B - Lepak
- C - Mešavina cementa i peska
- D - Strukturna košuljica - beton

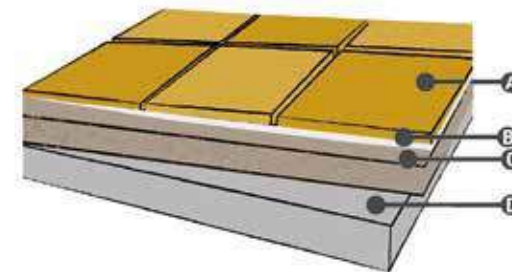

Rešenja za polaganje su ilustrativne prirode.



DRIVE-OVER FOR SLABS WITH 2, 3, 5, 6 CM (0.8", 1.2", 2", 2.4") THICKNESS



**VIDEO**



# IZDIGNUTO POSTAVLJANJE NA NOSAČE

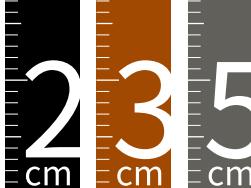

## PREDNOSTI

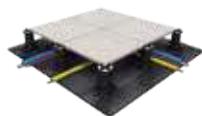

**Odlično za skrivanje instalacija**



**Uvek ravna i lako pristupačna površina**



**Bolja akustična i termo izolacija**

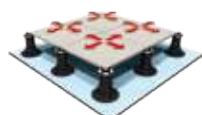

**Absorpcija pokreta**



**Brza instalacija**



**Izuzetna izdržljivost teretnog opterećenja**



**Značajna redukcija težine**



**Brza drenaža vode**



**Ekološko i čisto rešenje**



Izdignuto popločanje se sastoji od niza modularnih prilagodljivih nosača koji se lako i bezbedno prilagođavaju svakoj vrsti ploče. Dizajnirano je da čini homogenu površinu, bez radikalnih promena postojeće strukture. Takođe eliminiše probleme sa vlagom, infiltracijom vode i prolaskom električnih kablova i cevi. Ova vrsta montaže omogućava jednostavnu i efikasnu drenažu vode.



## MESTA PRIMENE

Rezidencijalna područja  
Komerzijalna područja  
Terase  
Bašte i dvorišta

## PRIMER IZDIGNUTOG POSTAVLJANJA

A - Ploče  
B - Prilagodljivi nosači  
C - Vodootporni omotač  
D - Košuljica sa nagibom do max. 5%

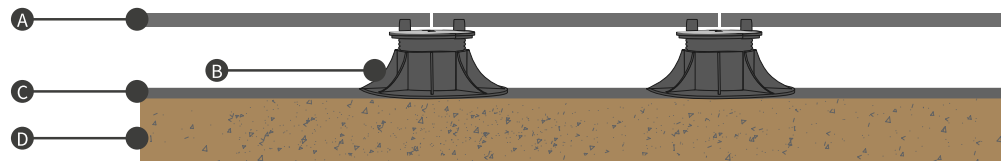

### SAVETI ZA POSTAVLJANJE

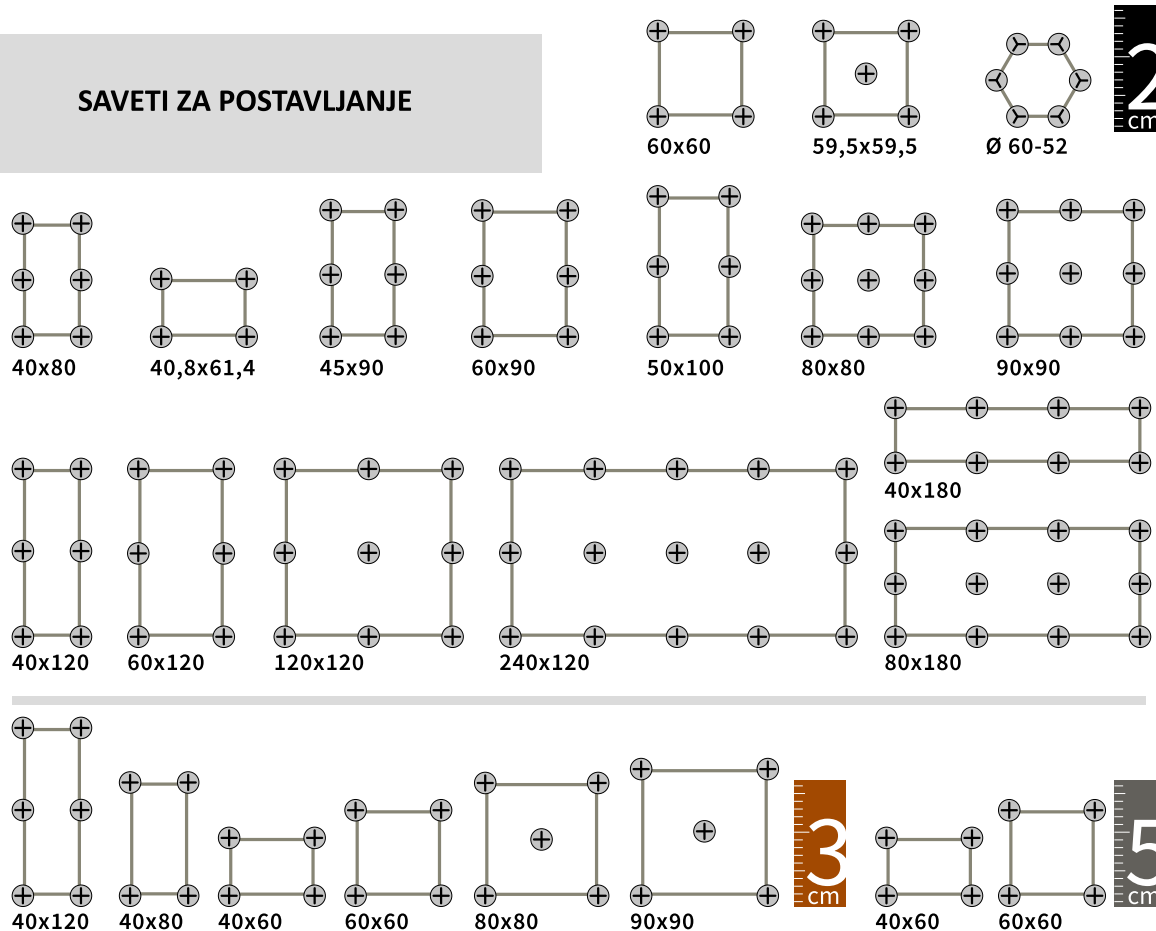

Prikazani dijagrami su ilustrativnog karaktera i prikazuju vrste postavljanja; potrebno je pridržavati se aktuelnih građevinskih normi i tehničkih standarda.

# NOSAČI

## PODESIVE FIKSNE STOPE



NM1

2,5 - 4 cm

NM2

4 - 7 cm

NM3

6 - 10 cm

NM4

9 - 16 cm

NM5

15 - 27 cm

## PODESIVE SAMONIVELIŠUĆE STOPE



SE0

2,8 - 3,8 cm

SE1

3,75 - 5 cm

SE2

5 - 7,5 cm

SE3

7,5 - 12 cm

SE4

12 - 17 cm

SE5

17 - 21,5 cm

## FIKSATORI/STAR T/KRSTIĆI



EH15

1,5 cm

STAR T

1 - 1,5 cm

CROCETTE

-

UPPER EDGE CLIP

-

LOWER EDGE CLIP

-

SIDE CLIP

-

KEY

-



## KLJUČ ZA PODEŠAVANJE

Podesivi nosači nude brojne mogućnosti pri nivelisanju bilo koje površine, od manjih nesavršenosti do visokih nagiba, kako bi se dobila ravna i stabilna površina. Ekskluzivni ključ za podešavanje prilagođava nosače (time i ploče koje su na njima) čak i u slučajevima gotovih podova, bez potrebe da se isti podiže.



VIDEO



# POSTAVLJANJE EASY PAVING METODOM

2 cm 3 cm

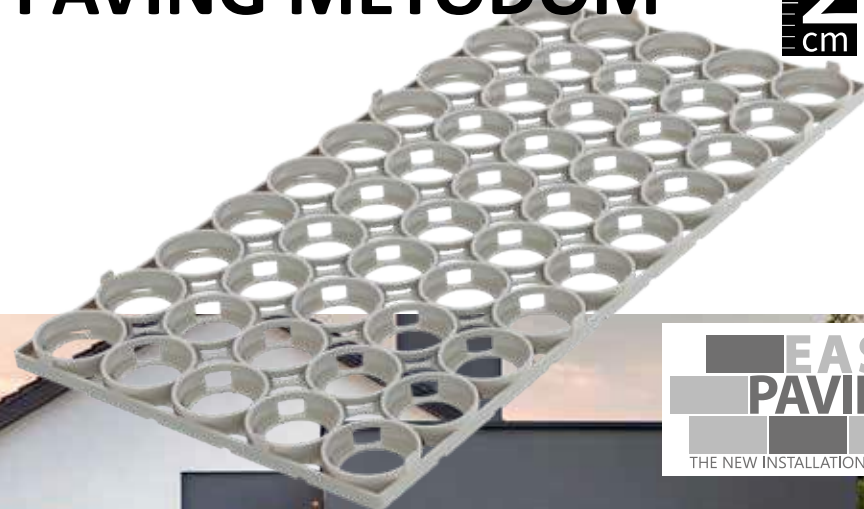

23 mm  
EASY PAVING  
+  
20 mm 30 mm  
2 cm 3 cm  
Ploča

Proizvod kompanije Granulati Zandobbio, dizajniran da omogući jednostavnije polaganje sinterovanog kamena veličina 40x80cm u dve debljine - 2cm i 3cm. Proizvod je napravljen od 100% reciklirane plastike i nakon upotrebe se može dalje reciklirati. Suvo postavljanje pojednostavljuje i ubrzava proces instalacije koje ne zahteva lepak ili cement. Njegova struktura sprečava oštećenja ploča u vidu krnjenja i održava spojeve jednakim u celoj površini koja se popločava, bez korišćenja distancera.

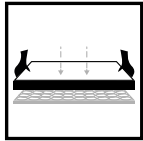

LAYING  
INSTALLATION

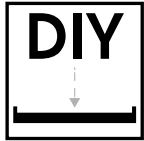

EASY TO LAY



NO GLUE AND  
CONCRETE

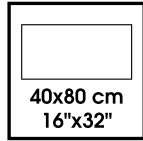

40x80 cm  
16"x32"  
40X80 CM  
SLABS

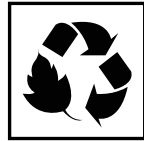

ECO-FRIENDLY

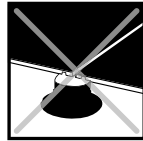

PEDESTALS NOT  
REQUIRED

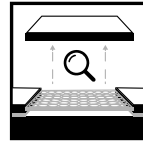

EASY TO REMOVE

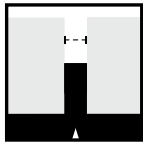

CONSTANT JOINT  
THICKNESS

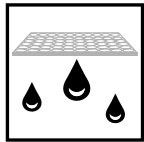

DRAINING



SOUND  
ABSORBING

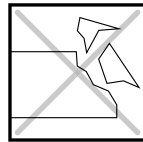

AVOIDS  
CHIPPING



COMFORTABLE  
PAVING

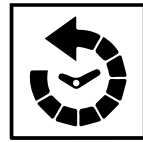

REUSABLE

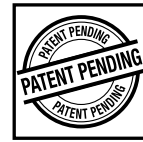

PATENT PENDING





# POSTAVLJANJE VENTILISANIH FASADA

## PREDNOSTI



ENERGY SAVING



THERMAL COMFORT



SELF-CLEANING



TECHNICAL  
PERFORMANCE



WEATHER-RESISTANT



IDEAL FOR  
RENOVATIONS

2  
cm



## VENTILISANE FASADE, KERF SISTEM

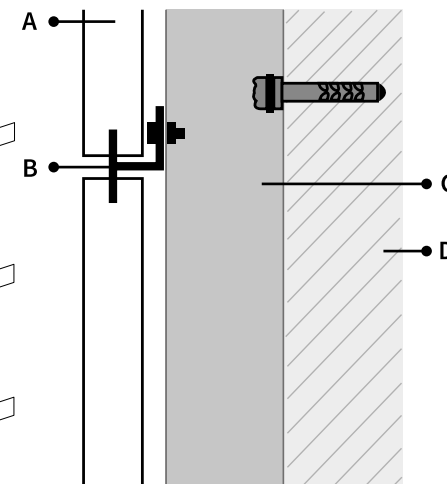
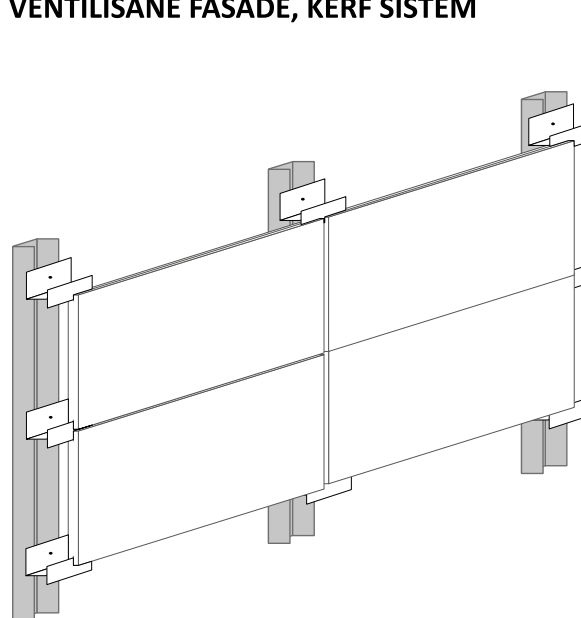

- A - Ploča
- B - Podupirač - nosač
- C - Struktura
- D - Zid

KERF tehnologija koja se primenjuje za postavljanje ploča debljine 2cm dozvoljava bezbedno ankerisanje zahvaljujući podupiračima, koji drže gornju ploču i sprečavaju prevrtanje donje ploče. Uz očigledne funkcionalne prednosti, ovaj sistem je cenovno efikasniji i garantuje veću otpornost na udare od ostalih sistema. Maksimalna preporučena veličina ploča je 120x120x2cm.



L'ALTRA<sup>®</sup>  
**PIETRA**  
 THE HIGH QUALITY  
**OUTDOOR PAVING**





## KEY



UNIFORM APPEARANCE

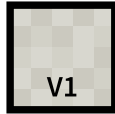

LIGHT COLOR VARIATION

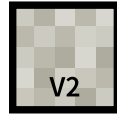

MEDIUM COLOR VARIATION

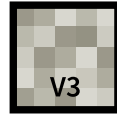

HIGH COLOR VARIATION



GUARANTEED ANTI-SLIP R10



GUARANTEED ANTI-SLIP R11

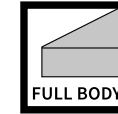

HOMOGENEOUS MIXTURE

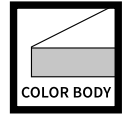

COLORED MIXTURE



RECTIFIED PRODUCT,  
WHERE NOT MENTIONED THE MATERIAL MUST ALWAYS  
BE CONSIDERED AS RECTIFIED



NATURAL PRODUCT FROM MOLDING,  
UNRECTIFIED

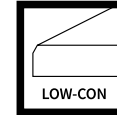

THE SLABS ARE RECTIFIED BEFORE BURNING ON PART  
OF THE THICKNESS IN ORDER TO LOWER THE CONICITY  
TYPICAL OF UNRECTIFIED SLABS

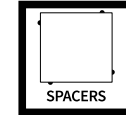

THE SLABS INCLUDE SPACERS THAT GUARANTEE JOINTS  
THICKNESS AND REDUCE INSTALLATION DURATION

### COLOR WARNING

Color shades shown in this catalog are merely indicative because the printed output undergoes significant changes compared to the original color.

The color shade of the slab can vary between different sizes of the same color.

### LAYING ADVICE

It is advisable to create the appropriate transverse and longitudinal gradients during levelling or compacting, in order to ensure optimal drainage of the floor. We recommend the incorporation of a drainage substrate in order to facilitate runoff and prevent water pooling. It is also advisable to lay the slabs with a minimum joint of 3mm.

Given the frost resistance of sintered stone, the slabs offer a water absorption value closed to zero. This property could lead to localised pooling of water on the floor, even if the slabs are laid properly.

### UPOZORENJE O BOJI

Nijanse koje su prikazane u katalogu su ilustrativne zato što štampani materijal prolazi kroz korekcije i ne daje realni prikaz originalne nijanse.

Nijanse iste boje mogu varirati u zavistnosti od veličine ploče.

### SAVETI ZA POSTAVLJANJE

Savetuje se da se napravi odgovarajući poprečni i uzdužni nagib u procesu nivelisanja kako bi se omogućila optimalna drenaža na podu. Preporučujemo upotrebu drenažnog substrata kako bi se postiglo oticanje vode odnosno sprečilo zadržavanje iste. Takođe preporučujemo da minimalna širina fuge bude 3mm.

Što se tiče otpornosti na mraz, vrednost absorpcije vode kod sinterovanog kamena je gotovo jednaka nuli.

Ova karakteristika može doprineti lokalnom nakupljanju vode na podu, čak iako su ploče postavljene na ispravan način.

# TECHNICAL FEATURES

		TECHNICAL FEATURES	STANDARD	ESTABLISHED LIMITS		1 CM	2 CM	3 CM	5 CM
REGULARITY		LENGHT AND WIDTH	ISO 10545-2	± 0,6 %	± 2 mm	COMPLYING			
		THICKNESS	ISO 10545-2	± 5,0 %	± 0,5 mm	COMPLYING			
		RECTANGULARITY	ISO 10545-2	± 0,5 %	± 2 mm	COMPLYING			
		STRAIGHTNESS OF SIDES	ISO 10545-2	± 0,5 %	± 1,5 mm	COMPLYING			
		SURFACE FLATNESS	ISO 10545-2	± 0,5 %	± 2 mm	COMPLYING			
STRUCTURAL		WATER ABSORPTION	ISO 10545-3	≤ 0,5 %		COMPLYING			
		BREAKING STRENGHT	ISO 10545-4	≥ 1300 N	≥ 1300 N	> 10000 N	* > 25000 N	> 67000 N	
		MODULUS OF RUPTURE		≥ 35 N/mm²	≥ 40 N/mm²				
	BREAKING LOAD CLASS	EN 1339	VALUE DECLARED	NA	* U 11	* U 30	U 30		
SURFACE		ABRASION RESISTANCE	ISO 10545-6	≤ 175 mm³	COMPLYING CONFORME ERFÜLLT CONFORME			NA	
		ISO 10545-7	CLASS DECLARED	≥ 3					
THERMAL HYGROMETRIC		LINEAR THERMAL-EXPANSION	ISO 10545-8	VALUE DECLARED	< 9*10 <sup>-4</sup> °C <sup>-1</sup>				
		THERMAL SHOCK RESISTANCE	ISO 10545-9	TEST PASSED	GUARANTEED				
		FROST RESISTANCE	ISO 10545-12	TEST PASSED	GUARANTEED				
CHEMICAL		RESISTANCE TO CHEMICALS (ACIDS, BASES AND SALTS)	ISO 10545-13	UB MINIMUM	GUARANTEED				
		RESISTANCE TO STAINS	ISO 10545-14	≥ 3	COMPLYING				
LIGHT		COLOR RESISTANCE TO LIGHT EXPOSURE	DIN 51094	NO NOTICEABLE COLOR MODIFICATIONS	COMPLYING				
SAFETY		SKID RESISTANCE	DIN 51130	VALUE DECLARED	R10 - R11		R11		

COMPLIANT WITH STANDARDS EN 14411 AND ISO 13006 ANNEX G GROUP BIa WITH E ≤ 0,5 % \* TECHNICAL VALUES REFERRED TO THE 60x60 cm SIZE

		TECHNICAL FEATURES	STANDARD	6 CM
STRUCTURAL		WATER ABSORPTION	EN 1338	< 0.30%
		INDIRECT TRACTION		> 10 N/mm²
		MONO-AXIAL COMPRESSION		> 190 N/mm²
SURFACE		ABRASION RESISTANCE		< 20 mm
SAFETY		SKID RESISTANCE		> 60

## CERTIFIED COMPANY

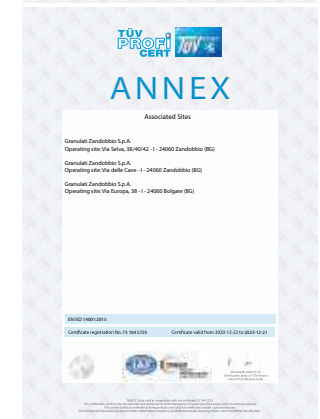
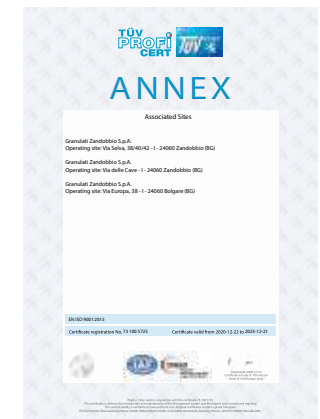



GENERALNI UVOZNIK I DISTRIBUTER:



Dugo polje 38, 11226 Beograd  
+381 11 3908-178 +381 11 3908-224  
office@ilgrad.rs  
www.ilgrad.rs